

Manual

BlueMon Ammonium

Commissioning and Maintenance

Ammonium
488 2FA0

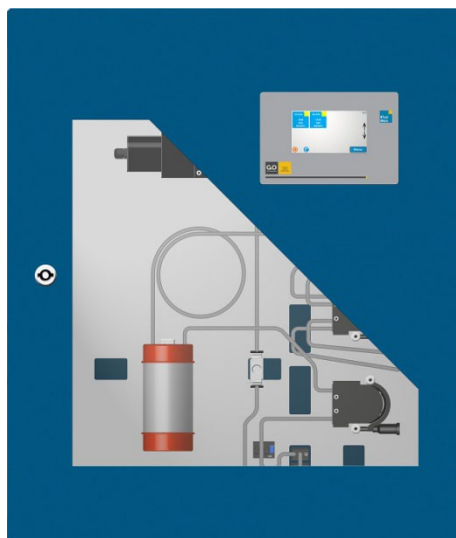

Copyright

According to the protective notes of DIN ISO 16016

"The reproduction, distribution and utilization of this document as well as the communication of its contents to others without express authorization are prohibited. Offenders will be held liable for the payment of damages. All rights reserved in the event of patent, utility model or design registration."

Changes

GO Systemelektronik GmbH retains the right to modify the contents of the manual without prior notice.

Liability exclusion

GO Systemelektronik GmbH takes no responsibility for correct system operation under all possible operating conditions. It is not possible to guarantee that the software will function completely without error under all possible circumstances. GO Systemelektronik GmbH therefore disclaims all liability for any direct or indirect damage resulting from system operation or the contents of this manual.

Product observance

Within the scope of our obligation for product observance GO Systemelektronik GmbH will endeavour to warn third parties about all identified dangers which could arise from the interaction between hardware and software and from the use of other components. Effective product observance is only possible with adequate information from the end user about the planned field of application and the hardware and software used. If the conditions of use change or if the hardware or software is changed, due to the complex relationships between hardware and software, it is no longer possible to describe all possible dangers and their effects on the total system, in particular on our system. This manual does not describe every possible property and combination of the system. For further information, please contact GO Systemelektronik GmbH.

Manufacturer's declaration

When installing the system it is necessary to ensure correct electrical connection, protection against moisture and foreign bodies and excessive condensation, and system heating which can arise from both correct and incorrect use. It is the responsibility of the installer to ensure that the correct installation conditions are provided.

Table of contents

1 Introduction	4
2 Device Information	5
2.1 Hazard Notes.....	5
2.2 Notes on Operation.....	5
2.3 Operation Conditions.....	6
2.4 Measurement Method.....	6
2.5 Technical Data	7
2.6 Housing.....	8
2.7 Device Configuration of the Analyser Plate	9
2.8 Connections.....	10
2.9 Tubing Diagrams.....	11
2.9.1 Tubing Diagram I.....	11
2.9.2 Tubing Diagram II.....	12
2.9.3 Tubing Diagram III.....	13
2.9.4 Tubing Diagram IV.....	14
2.10 Consumption Material (Tubing-set).....	15
2.11 Spare Parts	15
2.12 Chemicals	16
3 Installation	17
3.1 Wall Mounting	17
3.2 Connection of Chemicals and Waste	17
4 Commissioning	18
4.1 Switching On the BlueMon	19
4.2 Initial Filling.....	20
4.2.1 Reagents Supply.....	20
4.2.2 Samples Supply	20
4.2.3 Calibration Liquids Supply.....	21
4.2.4 Cleaning Fluid Supply	21
4.3 Test Run	22
4.4 Calibration.....	23
4.5 Operation Start	23
4.6 Notes on the Bubble Detector (Liquid Detector)	24
5 Decommissioning	25
6 Maintenance	26
6.1 Changing Chemicals.....	26
6.2 Changing Tubes and Tube Connectors	26
6.3 Cleaning (manual).....	26
6.4 Maintenance Intervals.....	26
6.5 Notes on the Sample Heating	26
7 Tube Changing at the Pump Head	27
7.1 Tube Bed Pump.....	27
7.2 Cassette Pump	28
7.3 Oiling the Pump Roller Axles	28
8 Replacement of the Cuvette on the Photometer and Spectralphotometer.....	29
Appendix A – Adjustment of the Touch Display.....	31
Appendix B – The Configuration Data Sheet.....	32
Appendix C – Maintenance Protocol.....	34
Appendix D – Connection Diagram of the Mainboard	35
Appendix E – Connection Diagram of the Plug-on Board (optional).....	36
Appendix F – Configuration of the Mainboard.....	37
Appendix G – Connection Diagram of the Current Outputs	38
Appendix H – Device Mounting (large housing).....	39
Appendix I – EU Declaration of Conformity.....	40

BlueMon Ammonium 2FA0 Commissioning and Maintenance

1 Introduction

This manual describes the **commissioning** and the **maintenance** of the BlueMon Analyser for Ammonium with the article number 488 2FA0

This manual describes only the commissioning and the maintenance of the BlueMon analyzer and not the operation at work.

Operation at work is described in the enclosed *Manual BlueMon Menu Operation*.

At the completion of this manual, the following types of design were available:

Type of design		Article number
I	<input type="checkbox"/> Dilution <input type="checkbox"/> Auto cleaning	488 2FA0-X-C2-OV-/
II	<input checked="" type="checkbox"/> Dilution <input type="checkbox"/> Auto cleaning	488 2FA0-X-C2-MV-/
III	<input type="checkbox"/> Dilution <input checked="" type="checkbox"/> Auto cleaning	488 2FA0-X-C2-OV-aR
IV	<input checked="" type="checkbox"/> Dilution <input checked="" type="checkbox"/> Auto cleaning	488 2FA0-X-C2-MV-aR

see also 2.9 *Tubing Diagrams*

To determine the type of the BlueMon, look at the shipping note.

The serial number of BlueMon stands on the type label right down ahead of the housing.

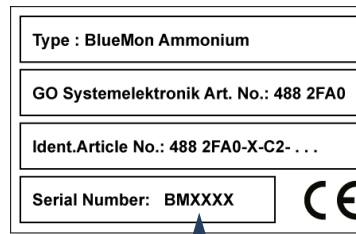

Serial number

The products of GO Systemelektronik are constantly being developed, therefore deviations between this manual and the delivered product can result. Please understand that no legal claims can be derived from the contents of this manual.

Safety instructions:



Danger: Used if non-observance threatens serious injury or death.



Warning: Used if non-observance threatens slight injuries or serious property damage.



Caution: Used if non-observance threatens minor property damage.



Symbol of safety instruction relating to the use of electricity.

2 Device Information

2.1 Hazard Notes



Danger: Improper handling of electrical devices endangers man and property.

The operation of the BlueMon should only be performed by informed and trained staff using appropriate tools. Incorrect installation could cause serious faults and errors that may damage the device.



Danger: Improper handling of chemicals endangers humans and property.

The operation of the BlueMon should only be performed by informed and trained staff using appropriate tools. Read the allocated safety data sheets of the chemicals carefully and follow the appropriate instructions.

2.2 Notes on Operation



Never deliver the BlueMon to other persons without this manual. The manufacturer is not liable for improper or unintended usage.

This device is designed in accordance with the Low Voltage Directive and the safety regulations for electronic measurement devices.

The correct functioning and operational safety of the device can only be ensured, if in using the operator follows the generally applicable safety precautions and the specific safety instructions in this manual.

- Before connecting the BlueMon with the power supply, make sure that the supply voltage is according to the operation voltage of the BlueMon (see 2.5 *Technical Data* there *General Information*).
- The correct functioning and operational safety of the device can be ensured only within the climatic conditions specified in Chapter 2.3 *Operation Conditions* in this manual.
- Transporting the device from a cold to a warm environment may cause condensation and therewith function failures. In this case wait until the device temperature is similar to the ambient temperature, and then try a new start.
- Maintenance and repair work may only be performed by a trained person authorized from GO Systemelektronik.

If it can be assumed that the instrument can no longer be operated safely, it must be taken out of service and marked against an inadvertent use.

The security of the user can be affected by the device, if it for example:

- shows visible damages,
- does not work as prescribed any more
- was stored under inexpedient conditions for a longer time,
- was exposed to heavy transport conditions.

When in doubt, give notice to GO Systemelektronik GmbH and send, if necessary, the device for repair or maintenance to GO Systemelektronik GmbH.

2.3 Operation Conditions

A trouble-free operation of the BlueMon requires the fulfilment of the following conditions:

- No one-sided thermal radiation; no direct sunlight
- No vibrations
- The environmental conditions correspond to the IP protection code of the device. Environments with corrosive gases or vapours or with explosion hazard require additional protective precautions.
- Ambient temperature 15 - 35 °C; Humidity max 95 % (non-condensing)
- Operation only in a protected position
- The sample feeds must be free of solids and homogeneous, otherwise a filter must be installed. Samples with particle size > 30 microns require filtration.
- Maximum pressure of the inflowing sample is 0.05 bar, if necessary use a pressure reducer.
- The permissible range of the sample temperature is 10 to 40 °C, if necessary use cooling or heating.
- The BlueMon must be accessible for maintenance (illumination, free space, etc.).
- At an ambient temperature > 20 °C reagent cooling is recommended. A Reagent refrigerator can be ordered from GO Systemelektronik (Article-No. 416 5000-X).

2.4 Measurement Method

Ammonium occurs in ground and surface water and in municipal and industrial waste water.

Ammonium Nitrogen occurs in aqueous solutions in the form of NH_4^+ ions or NH_3 , depending on the pH value.

The ammonium reacts at a pH value of 12 - 13 with hypochlorite ions and salicylate ions in the presence of nitroprusside sodium as catalyst to a blue indophenol.

The proportion of the resulting indophenol blue is measured at a wavelength of 643 nm.

For ranges above 20 mg/l a dilution should be used.

2.5 Technical Data

extendable with the plug-on board, see Appendix E

Measurement	
Parameter	Ammonium-N in water
Measurement principle	Colorimetry at 643 nm; Indophenol blue
Measurement ranges	0 – 1 mg/l 0 – 8 mg/l 0 – 20 mg/l
Measurement accuracy	< 3 %
Measurement resolution	0,001 – 0,1 mg/l
Minimal process sequence duration	15 min
Calibration	Auto 2 point calibration
Sample lines	2 sample lines default Up to 6 sample lines optional

At ambient temperatures > 20 °C cooling of the reagents is recommended.

Reagent refrigerator: Article number 416 5000-X

Samples with particle size > 30 µm need filtration.

Sensors

1x Photometer (LED 643 nm, intensity adjustable)

1x Connector for pH glass electrode

1x Connector for temperature sensor PT1000 (0 – 80 °C)

1x Connector ORP (Redox) electrode (optional pH)

1x Current input 0 – 20 mA | 4 – 20 mA

4x Digital In

1x Connector for leakage sensor

1x Bubble detector (liquid detector for sample reagent lack)

1x Connector for additional bubble detectors

Expandable with CAN-bus and Modbus

Actuators

1x Sample heating at the digester connector with temperature measurement

1x Stirrer control

1x Motor control right/left

3x Motor control (direction of rotation manually switchable)

6x Relay 24 VDC/GND (called valve relays)

Free relays can be used as relay outputs.

4x Potential-free relays, max. switching voltage 48 V

Expandable with CAN-bus and Modbus

BlueMon Ammonium 2FA0 Commissioning and Maintenance

Interfaces

1x Ethernet (Modbus TCP)

1x RS-232 or RS-485 (Modbus)

1x CAN-bus (for connecting further modules, sensors and actuators)

2x Current output¹

0 – 20 mA | 4 – 20 mA

General Information

Voltage supply Input voltage 85 – 264 VAC; 47 – 63 Hz | 120 – 370 VDC

Power consumption typical 80 W

IP protection code IP54 (optional IP65)²

Colour display Touchpanel 480 x 272 pixel

Housing	Material	Steel, powder-coated
	Dimensions (WxLxH)	60 x 70 x 31 cm
	Colour	RAL 5010 (blue)

Empty weight approx. 45 kg

Sample pressure 0 bar (max. 0.05 bar overpressure)

Sample flow rate 2 – 10 l/h, no suspended solids

Sample temperature 10 – 40 °C

Ambient temperature 15 – 35 °C

Computer PC 104; 800 MHz; access memory 256 MB

Storage memory Industrial NANDrive™ 512 MB; optional 2 GB

Operating system embedded Linux™

2.6 Housing

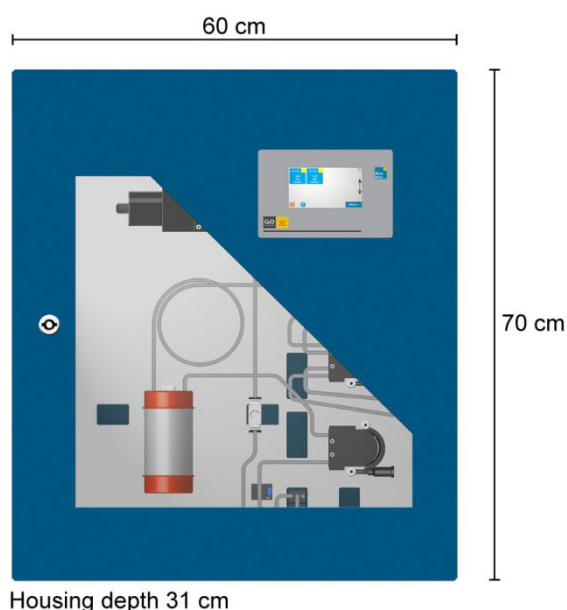

¹ Strictly speaking, a current output is not an interface, but an analogue actuator.

² Precondition for compliance with the IP protection code is the use of appropriate protective caps and plugs.

2.7 Device Configuration of the Analyser Plate

Photometer Ammonium Analyser 488 2FA0 (large housing)

Front

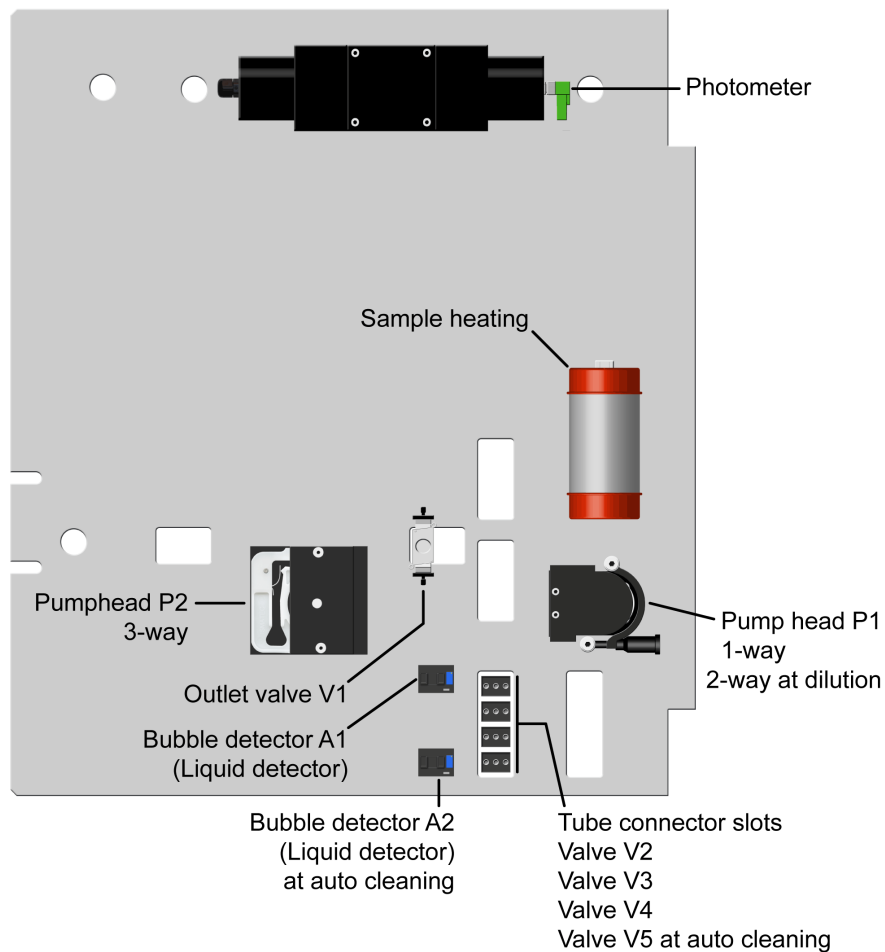

Rear

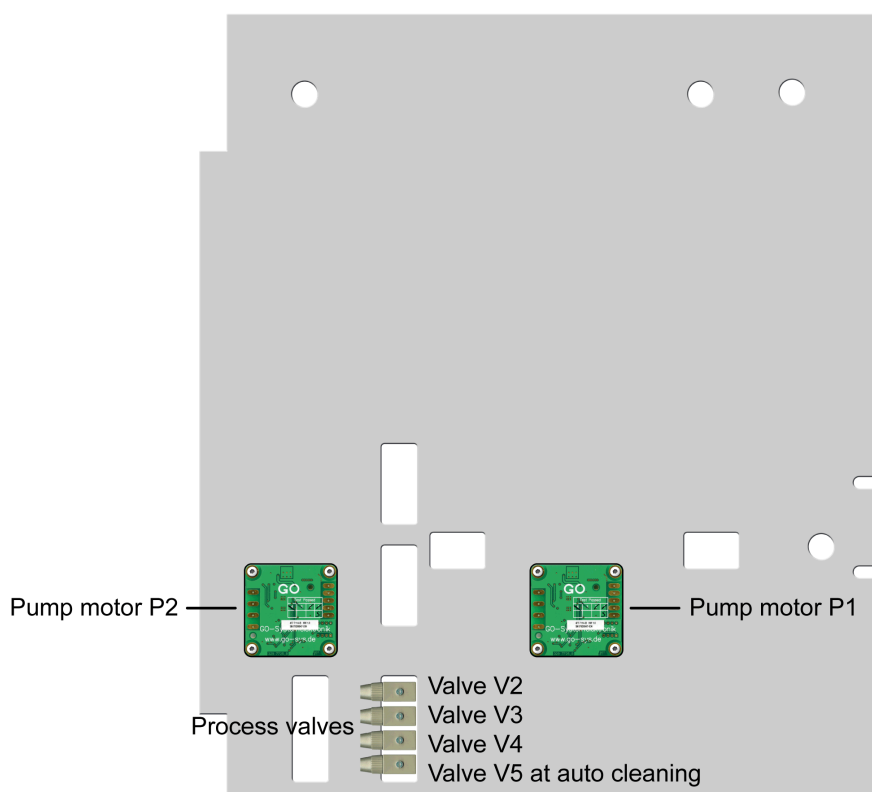

2.8 Connections

The BlueMon has the following electrical connection options:

The connectors are located at the top left on the left side of the housing.

- ① Power cable guide with bend protection (85 – 264 VAC)
- ② Additional PG glands, e.g. for an antenna cable
- ③ Connection for a LAN cable in standard or cross-link design with protection cap

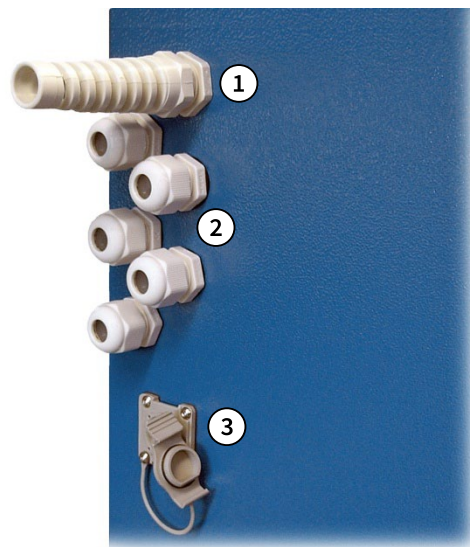

The BlueMon has the following liquid connectors:

The connectors are located at the lower left on the right side of the housing.

- ① Supply connector Sample 1
 - ② Supply connector Sample 2
 - ③ Drain connector
- Additional: Holes with protection caps

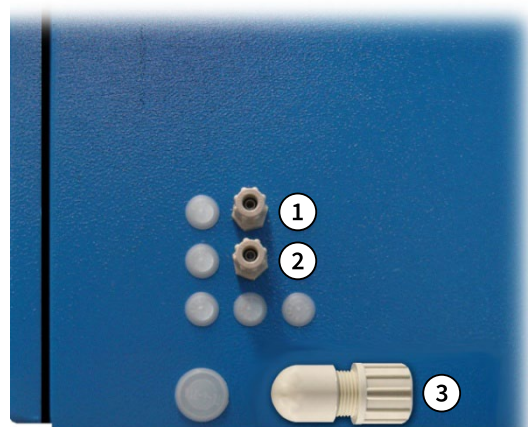

Mainboard and, if existing, plug-on board of the BlueMon are located behind the analyser plate on the back of the housing. The boards are protected by a metal cover; the metal cover is fixed with four M4 screws. On the boards there are further connectors: CAN-bus, Modbus, current output etc. (see Appendix D and Appendix E).

Modems (optional): • UMTS/HSPA modem with antenna • Analogue modem • ISDN-modem

BlueMon Ammonium 2FA0 Commissioning and Maintenance

2.9 Tubing Diagrams

2.9.1 Tubing Diagram I

Dilution Auto cleaning

Photometer - Ammonium - 488 2FA0 - large housing

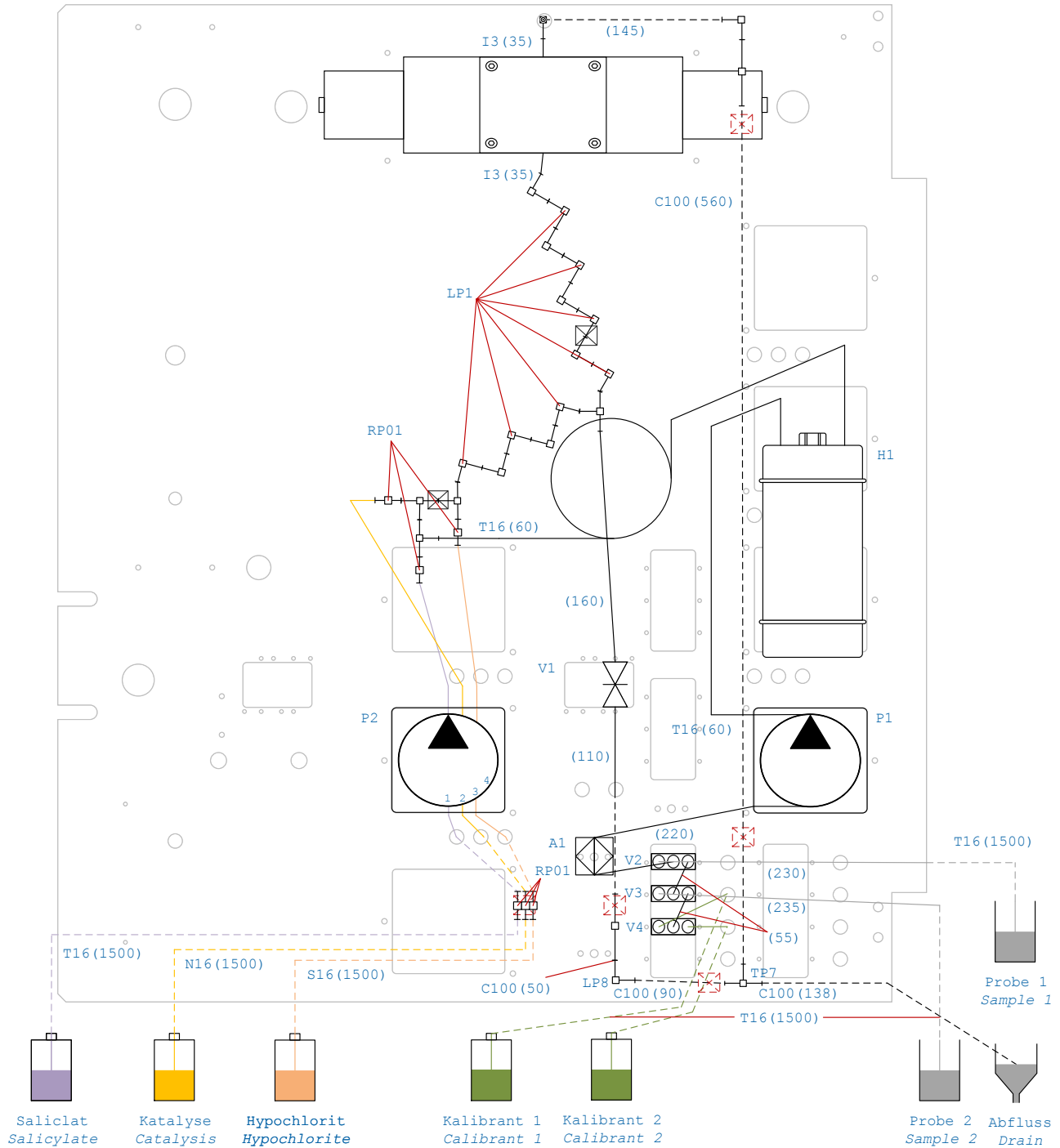

Legende / Description of figures





Fotometer: LED 643 nm
Photometer: LED 643 nm

Pumpenschlauch / Pump tubing:
 P1: M48
 P2-1/-2/-3: or-or



PX-1 vorne/front
 PX-2 hinten/back

Ablaufschlauch: C100(1500)
Drain Tubing: C100(1500)



Schlauchbezeichnung: Typ(Länge)
Tubing Description: Type (Length)
 Sofern nicht anders bezeichnet: T24(20)
 If not otherwise indicated: T24(20)

 LP2
  TP2
  VP2
  RP92

- - - - Schlauch auf der Rückseite
 Tubing on the reverse side
 ————— Schlauch auf der Vorderseite
 Tubing on the frontside
 optionales Bauteil
 Element optional

NO  NC 
 Ventil AN Ventil AUS
 Ventile ON Ventile OFF
 NO - Normally open
 NC - Normally closed

Fixierung / Fixation

 Art no. 330 9760
 Art no. 330 9761
 Art no. 330 9762

BlueMon Ammonium 2FA0 Commissioning and Maintenance

2.9.2 Tubing Diagram II

Dilution Auto cleaning

Photometer - Ammonium - 488 2FA0 - large housing

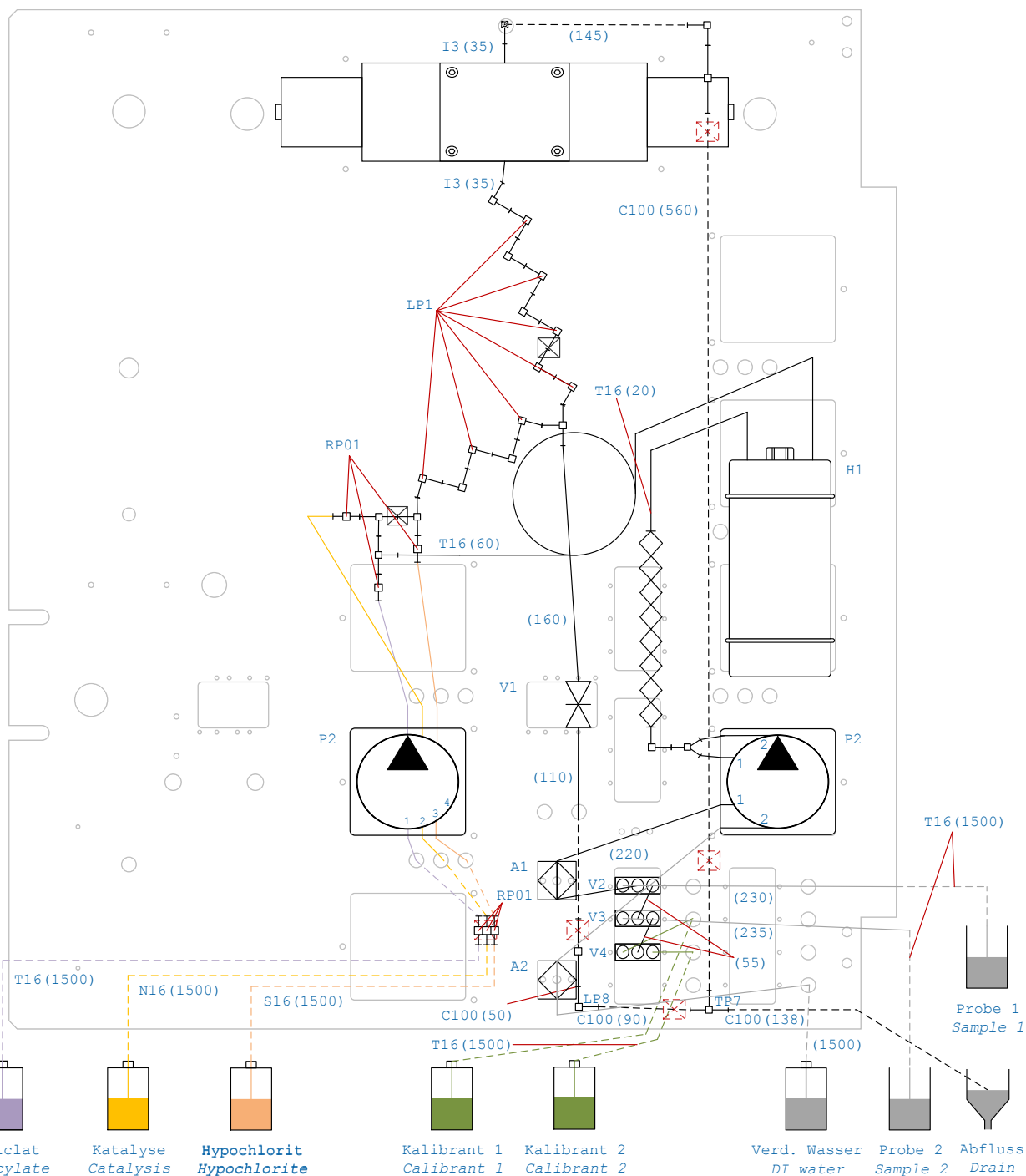

Legende / Description of figures

Fotometer: LED 643 nm
Photometer: LED 643 nm

Pumpenschlauch / Pump tubing:
P1-1: M48
P1-2: T16
P2-1/-2/-3: or-or

PX-1 vorne/front
PX-2 hinten/back

Ablaufschlauch: C100(1500)
Drain Tubing: C100(1500)

Schlauchbezeichnung: Typ(Länge)
Tubing Description: Type (Length)
 Sofern nicht anders bezeichnet: T24(20)
 If not otherwise indicated: T24(20)

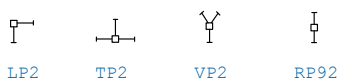

----- Schlauch auf der Rückseite
 Tubing on the reverse side
 _____ Schlauch auf der Vorderseite
 Tubing on the frontside
 optionales Bauteil
 Element optional

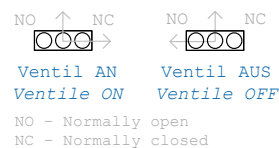

Fixierung / Fixation

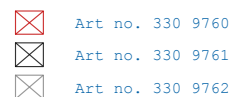

BlueMon Ammonium 2FA0 Commissioning and Maintenance

2.9.3 Tubing Diagram III

Dilution Auto cleaning

Photometer - Ammonium - 488 2FA0 - large housing

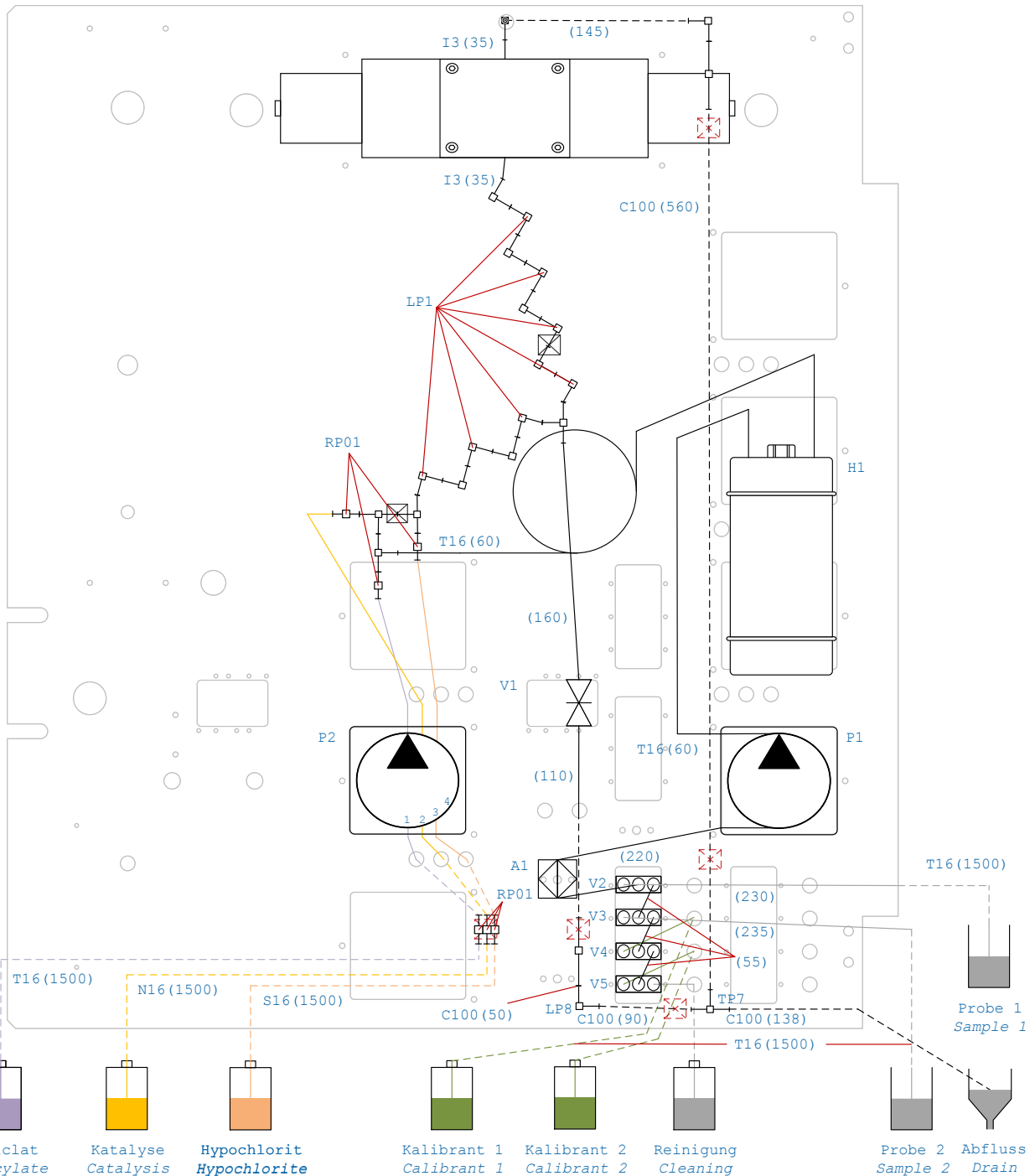

Legende / Description of figures





Fotometer: LED 643 nm
Photometer: LED 643 nm

Pumpenschlauch / Pump tubing:
P1-1: M48
P1-2: T16
P2-1/-2/-3: or-or



PX-1 vorne/front
PX-2 hinten/back

Ablaufschlauch: C100(1500)
Drain Tubing: C100(1500)



Schlauchbezeichnung: Typ(Länge)
Tubing Description: Type(Length)
 Sofern nicht anders bezeichnet: T24(20)
 If not otherwise indicated: T24(20)

 LP2
  TP2
  VP2
  RP92

- - - - - Schlauch auf der Rückseite
 Tubing on the reverse side
 ————— Schlauch auf der Vorderseite
 Tubing on the frontside
 optionales Bauteil
 Element optional

NO  NC 
 Ventil AN Ventil AUS
 Ventile ON Ventile OFF
 NO - Normally open
 NC - Normally closed

Fixierung / Fixation

 Art no. 330 9760
 Art no. 330 9761
 Art no. 330 9762

BlueMon Ammonium 2FA0 Commissioning and Maintenance

2.9.4 Tubing Diagram IV

☑ Dilution ☑ Auto cleaning

Photometer - Ammonium - 488 2FA0 - large housing

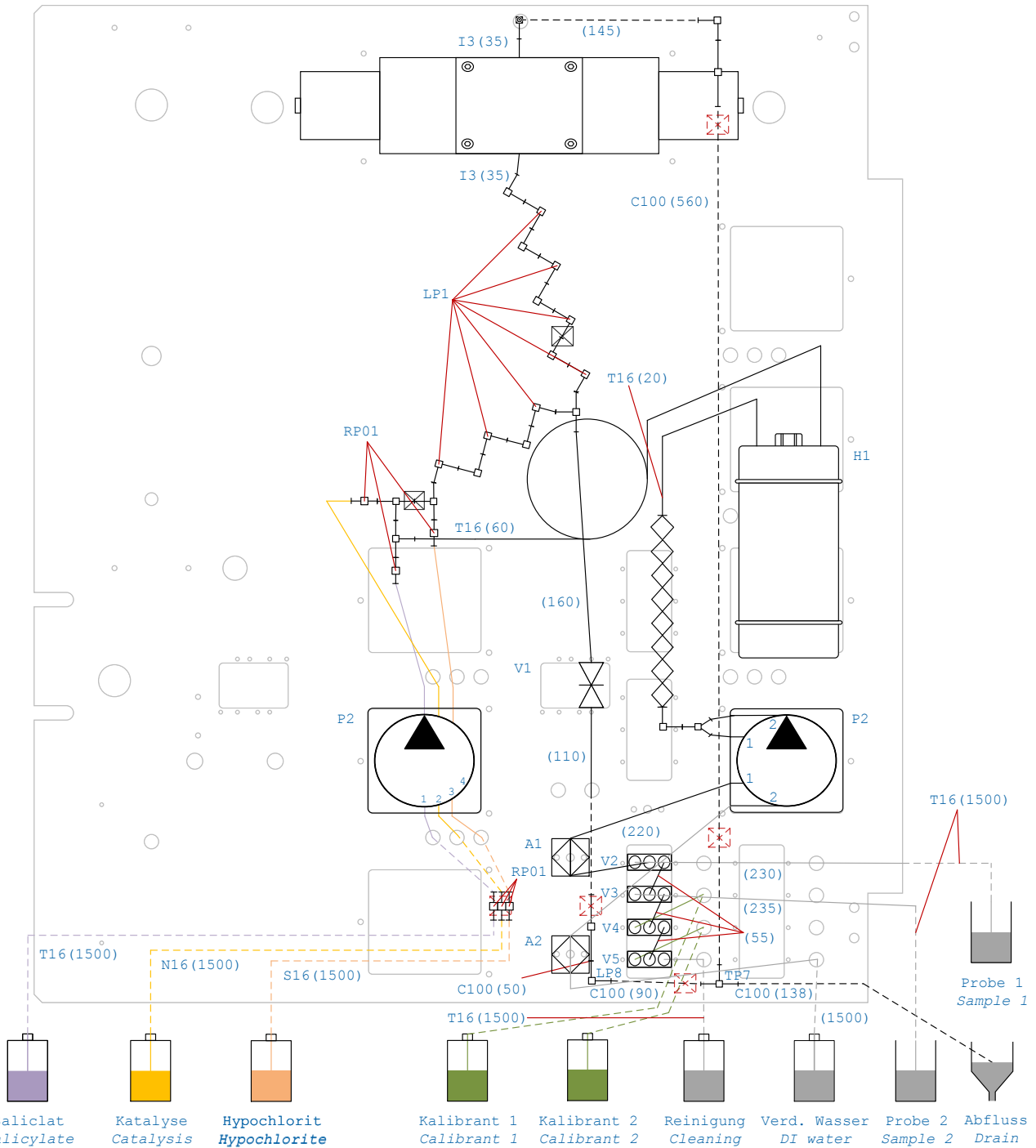

Legende / Description of figures

Fotometer: LED 643 nm
Photometer: LED 643 nm

Pumpenschlauch / Pump tubing:
P1-1: M48
P1-2: T16
P2-1/-2/-3: or-or

PX-1 vorne/front
PX-2 hinten/back

Ablaufschlauch: C100(1500)
Drain Tubing: C100(1500)

Schlauchbezeichnung: Typ(Länge)
Tubing Description: Type (Length)
 Sofern nicht anders bezeichnet: T24(20)
 If not otherwise indicated: T24(20)

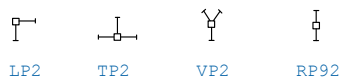

----- Schlauch auf der Rückseite
Tubing on the reverse side
 _____ Schlauch auf der Vorderseite
Tubing on the frontside
 optionales Bauteil
Element optional

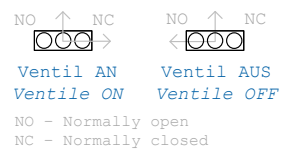

Fixierung / Fixation

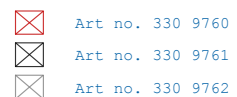

2.10 Consumption Material (Tubing-set)

BlueMon Ammonium 488 2FA0 from serial number BM1080

The consumption material consists of the following components. We recommend ordering the consumption material as a whole (Article No. 418 6051).

Designation	Article No.	Number/Length	at Dilution	at Auto cleaning
Tube S16	330 7510	1520 mm		
Tube I3	330 7538	70 mm		
Tube C100	330 7544	840 mm		
Tube T24	330 7545	1600 mm		
Tube T16	330 7549	8000 mm	+1500 mm	+1500 mm
Tube N16	330 7551	1520 mm		
Pump tube T16	330 7552		1 Pcs.	
Pump tube M48	330 7553	1 Pcs.		
Pump tube OR/OR	330 7566	3 Pcs.		
Mixer	330 9618		1 Pcs.	
Tube connector TP2	330 9750	4 Pcs.		
Tube connector LP2	330 9751	8 Pcs.	1 Pcs.	
Tube connector TP7	330 9752	1 Pcs.		
Tube connector RP92	330 9753	2 Pcs.		
Tube connector LP8	330 9754	1 Pcs.		
Tube connector VP2	330 9755		1 Pcs.	
Tube connector LP1	330 9756	7 Pcs.		
Cable tie	335 7000	8 Pcs.		

2.11 Spare Parts

Designation	Article No.	Number	at Dilution	at Auto cleaning
Peristaltic pump 2-way	363 6027		1 Pcs.	
Peristaltic pump 1-way	363 6028	1 Pcs.	-1 Pcs.	
Multichannel- Peristaltic pump with motor and 3 tube cassettes	363 6029-3	1 Pcs.		
Process valve set (V2 – V5)	442 0008	3 Pcs.		+1 Pcs.
Outlet valve set (V1)	442 0009	1 Pcs.		
Bubble detector (Liquid detector)	461 6501	1 Pcs.	+1 Pcs.	
Photometer 643 nm	461 6800 643	1 Pcs.		
Sample heating	462 0030	1 Pcs.		

2.12 Chemicals

Article No. of the chemicals set: 418 5008

The annual consumption varies with the measurement range to which the analyzer is calibrated. The higher the measurement range, the lower the annual consumption. Furthermore, high measurement ranges above 20 mg/l NH₄-N require dilution. This results in an additional consumption of DI water.

The following annual consumption values show the average consumption for a measuring range with a maximum of 20 mg/l NH₄-N in continuous operation with one calibration per week.

Reagents for ammonium detection	
Catalysis dilution	45 L/Year
Hypochlorite dilution	45 L/Year
Salicylate dilution	45 L/Year
Calibration standards	
Zero standard	12 L/Year
Ammonium standard *	12 L/Year

* The concentration depends on the measurement range.

Cleaning fluid	15 L/Year
----------------	-----------



Caution: The reagents must be stored away from UV light.
The catalysis solution must be stored in a cool place.
Observe safety data sheets section 7!

3 Installation

3.1 Wall Mounting

The BlueMon is designed for wall mounting. Four screwed wall mountings are located in the corners at the back of the device. see *Appendix H– Device Mounting (small housing)*

The BlueMon must be accessible for maintenance (illumination, free space, etc.).



Warning: The condition of the wall and the mounting material must carry the total weight of the BlueMon (case, reagents, liquids etc.). Depending on the equipment the BlueMon can weigh up to 105 kg. We recommend a mounting with M8 threaded bolts in anchors in a concrete wall.



Warning: The BlueMon must not fall or tip over. Use suitable handling devices (crane, shoulder straps etc.).

Check the attached tipping or shock indicators of the transport box and the housing for evidence of improper transport.

Take the device with suitable load suspension equipment out of the transport box.

After wall mounting open the housing door and remove the foam blocks from the analyser plate, loosen the knurled nut of the analyser plate, swing out the analyser plate and remove the transport locks here also. It is recommended to keep the protective materials for reuse. In case of using a reagent refrigerator from GO Systemechnik, screw this firmly on the bottom side of the housing (if not supplied already screwed). You can also mount the reagent refrigerator separately.

3.2 Connection of Chemicals and Waste

1. Place the required chemicals in the transport canister underneath the device or into the reagent refrigerator (Article-No. 416 5000-X). Make sure that the height difference between the canisters and the connected pumps does not exceed 1000 mm.
2. If you want to use dilution water in your application, place DI water.
3. Insert the tube ends into the corresponding containers (see *2.9 Tubing Diagram*) and screw the tube firmly.



Caution: Make sure that the reagents and calibration liquids are connected to the appropriate tubing. *see 2.9 Tubing Diagram*



Warning: The liquid feeding must take place almost without pressure (max. 0.05 bar).



Caution: Make sure that the sink is not corroded by the chemicals. Observe local discharge requirements.



Note necessary protective measures! see safety data sheet



Observe personal protective measures!

4 Commissioning

Precondition: approved and complete installation in accordance with 3 *Installation*

Commissioning procedure:

1. Switch on the BlueMon, see 4.1
2. Initial filling, see 4.2
 - a. Reagents supply, see 4.2.1
 - b. Samples supply, see 4.2.2
 - c. Calibration liquids supply, see 4.2.3
 - d. Cleaning liquid supply, see 4.2.3
3. Test run, see 4.3
4. Calibration, see 4.4
5. Operation start, see 4.5

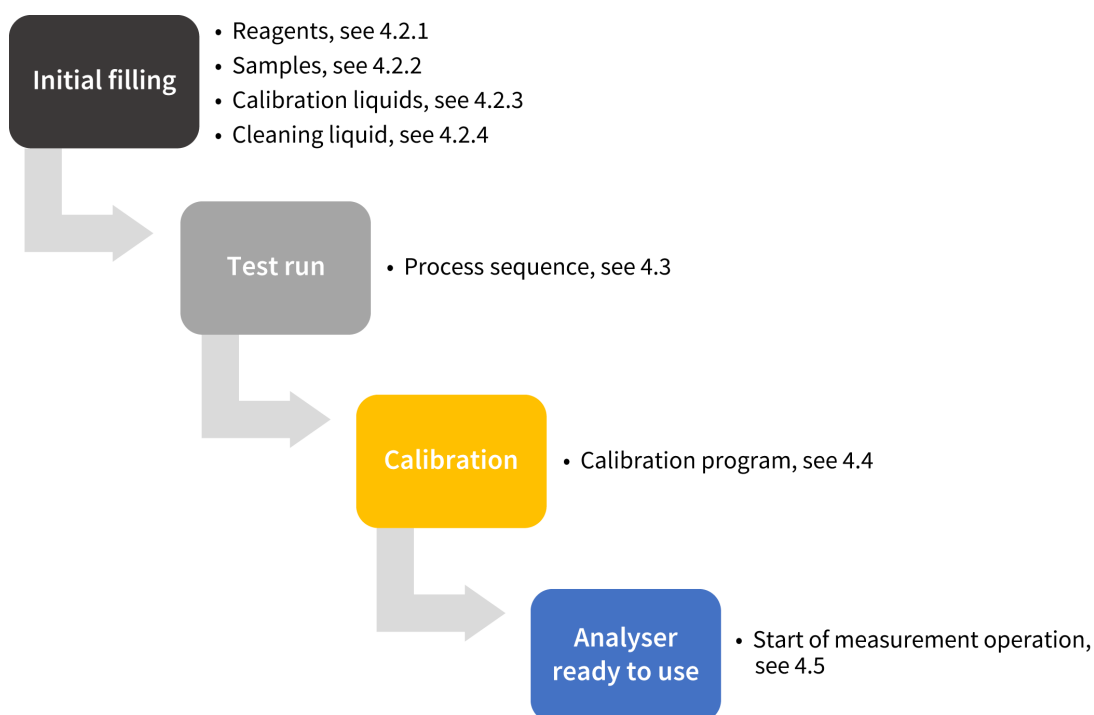

Note: Switching states of the valves

Valve not switched



Valve switched



Valve not switched

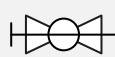

Valve switched

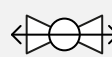

4.1 Switching On the BlueMon



Danger

- Close the housing door.
- Blockages in the tube system can loosen tube connections. As a result, hazardous liquids may leak out.

After the Blue Box has been started by switching on the power supply, the display shows following information in succession.

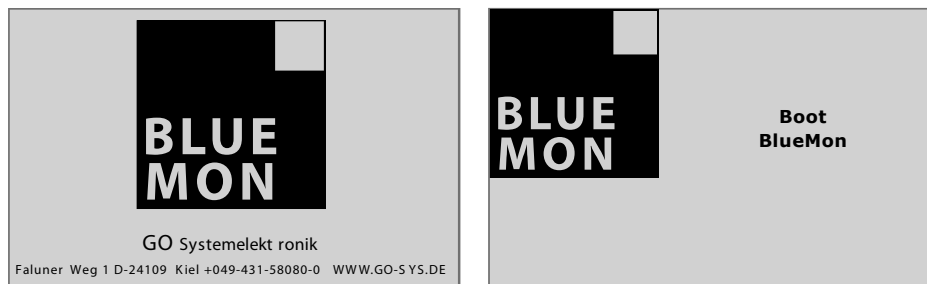

Then the BlueMon initiates the connected sensors and actuators.

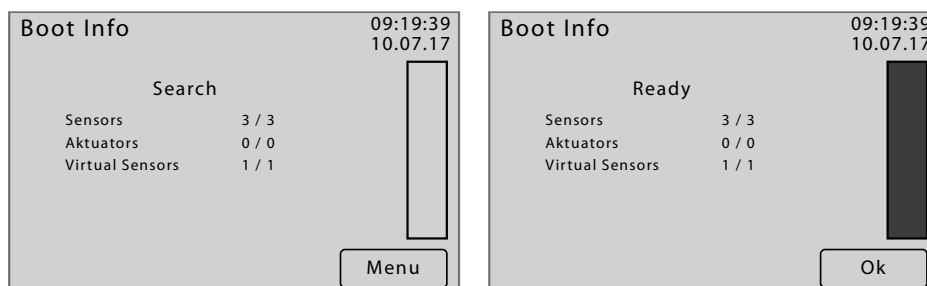

Once the initialization is complete, the display shows the number of connected sensors and actuators.

After 20 seconds or after pressing <OK> the Parameter display appears.

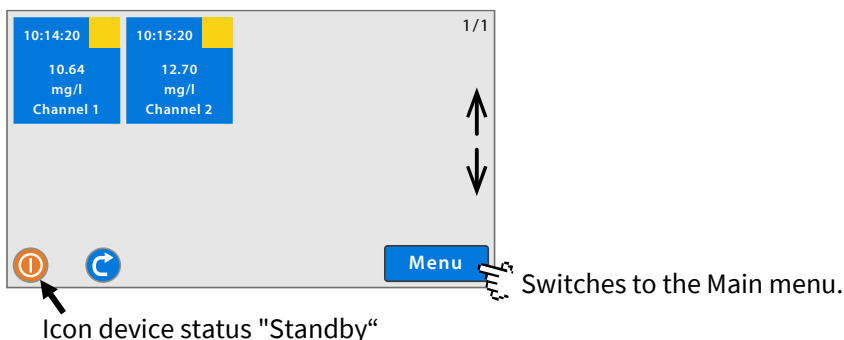

Icon device status "Standby"

Password input

To access certain menus, a password consisting of 5 digits must be entered.

The password can be found in the configuration data sheet.

see *Appendix B – The Configuration Data Sheet* there 1. *BlueMon* there *BlueMon Password (PIN)*

Password	1	2	3	
	4	5	6	
* * * *	7	8	9	
	0	<		
	<-			

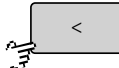
Deletes the last entered digit.

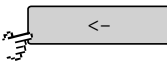
Verifies the password and switches forward. If the password is incorrect, you receive an error message.

4.2 Initial Filling

4.2.1 Reagents Supply

- **Reagents** ⇒ Inlet Catalysis dilution and Inlet Hypochlorite dilution and Inlet Salicylate dilution
To perform the manual initial filling of the BlueMon with reagents, start pump 2 until all reagents are transported to the pump.

see *Manual BlueMon Menu Operation* there 8.2.1.1 *Manual Pump and Valve Relay Control*

Menu operation

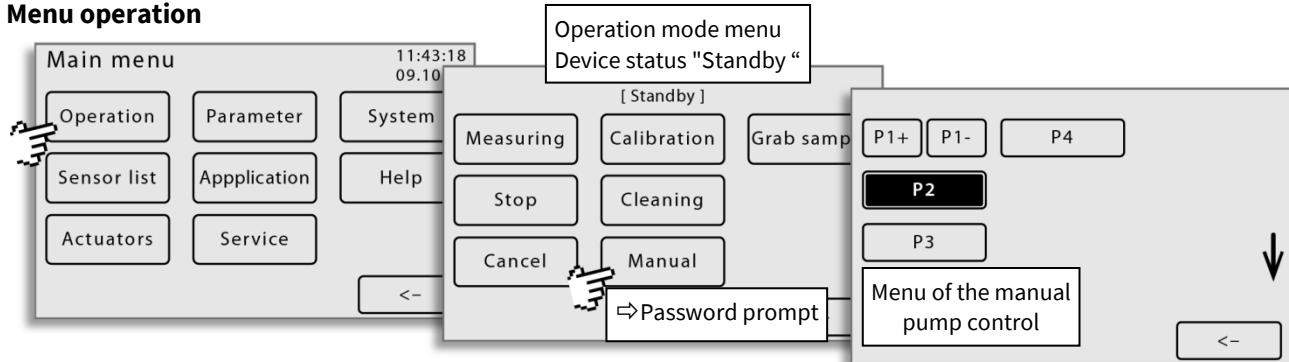

! Note: When the menu of the manual pump control is called up, a running process sequence is immediately interrupted; a running single sequence program is terminated immediately. All pumps and valves go into idle state. As soon as you switch back to the operating mode menu, the interrupted process sequence starts with the next  sequence element.

4.2.2 Samples Supply

- **Sample 1** – To perform the manual initial filling of the BlueMon with sample liquid 1, start pump 1 in anti-clockwise direction <P1-> in the menu operation until the sample liquid is transported to the pump.
- **Sample 2** – To perform the manual initial filling of the BlueMon with sample liquid, start pump 1 in anti-clockwise direction <P1-> in the menu operation while valve 2 is switched, until the sample liquid is transported to the pump.
DI water – Optionally, pump 1 is mounted as a two-channel pump, which can pump both the sample and the DI water.

see *Manual BlueMon Menu Operation* there 8.2.1.1 *Manual Pump and Valve Relay Control*

Menu operation

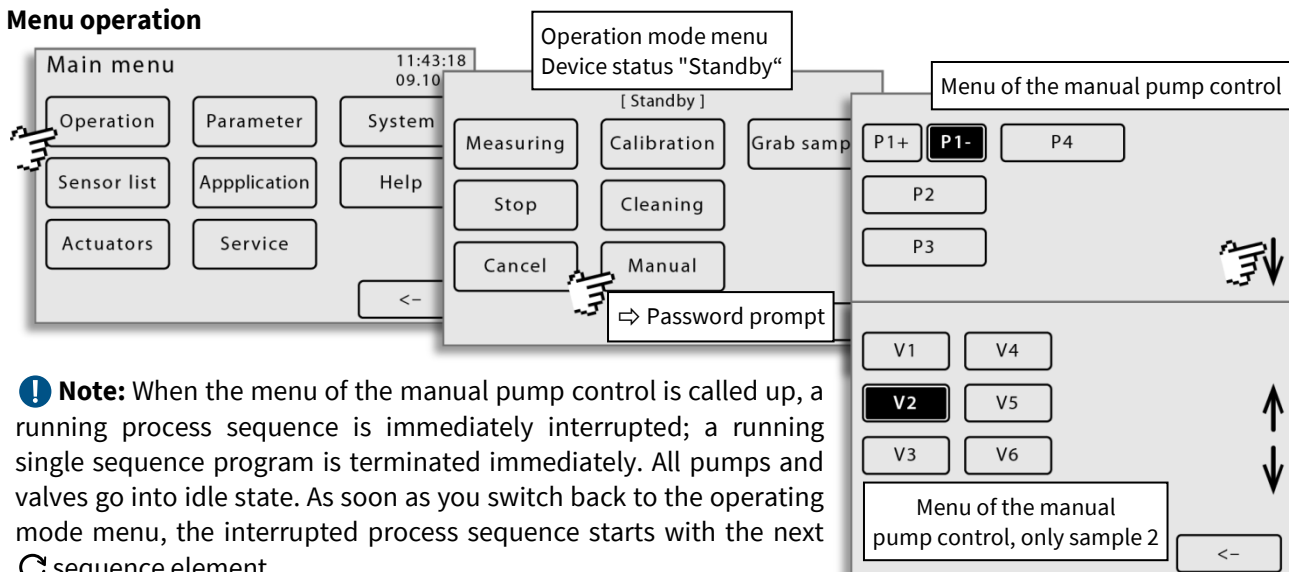

! Note: When the menu of the manual pump control is called up, a running process sequence is immediately interrupted; a running single sequence program is terminated immediately. All pumps and valves go into idle state. As soon as you switch back to the operating mode menu, the interrupted process sequence starts with the next  sequence element.

4.2.3 Calibration Liquids Supply

- **Calibration liquid 1**

To perform the manual initial filling of the BlueMon with calibration liquid, start pump 1 in anti-clockwise direction <P1-> in the menu operation while valve 2 and valve 3 are switched until calibration liquid 1 is transported to the valve connection at the tube connector slot.

- **Calibration liquid 2**

Add valve 3 until the calibration liquid 2 is transported to the valve connection at the tube connector slot.

Menu operation

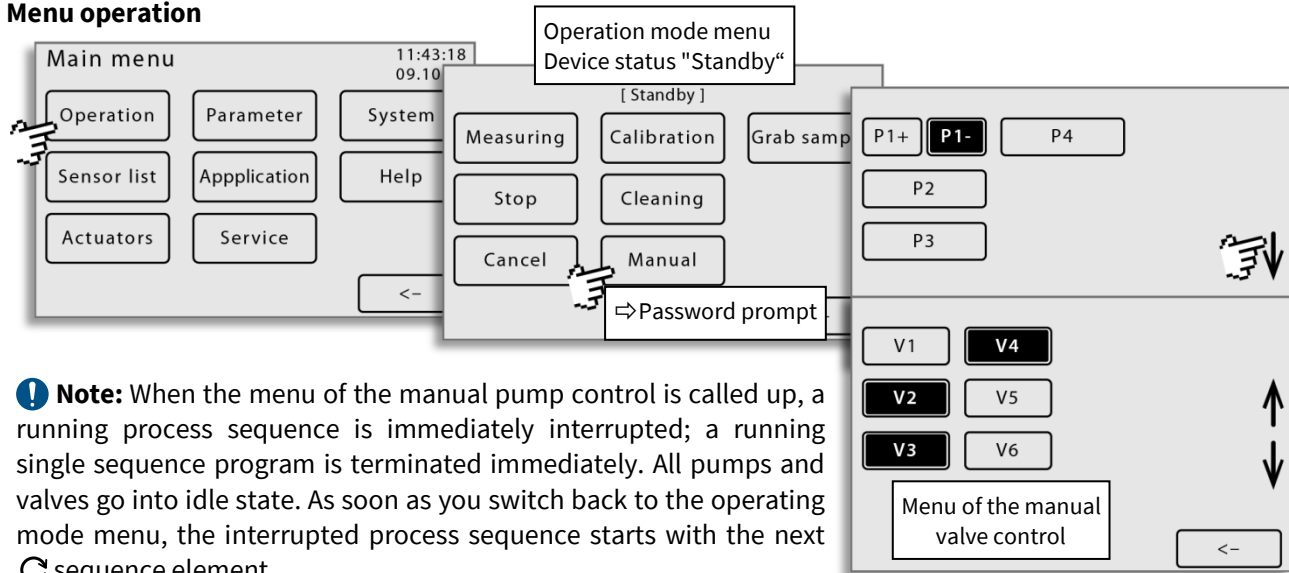

! Note: When the menu of the manual pump control is called up, a running process sequence is immediately interrupted; a running single sequence program is terminated immediately. All pumps and valves go into idle state. As soon as you switch back to the operating mode menu, the interrupted process sequence starts with the next sequence element.

4.2.4 Cleaning Fluid Supply

- **Cleaning fluid**

To perform the manual initial filling of the BlueMon with cleaning fluid, start pump 1 in anti-clockwise direction <P1-> in the menu operation while valve 2 and 5 are switched until the cleaning liquid is transported to the valve connection at the tube connector slot.

Menu operation

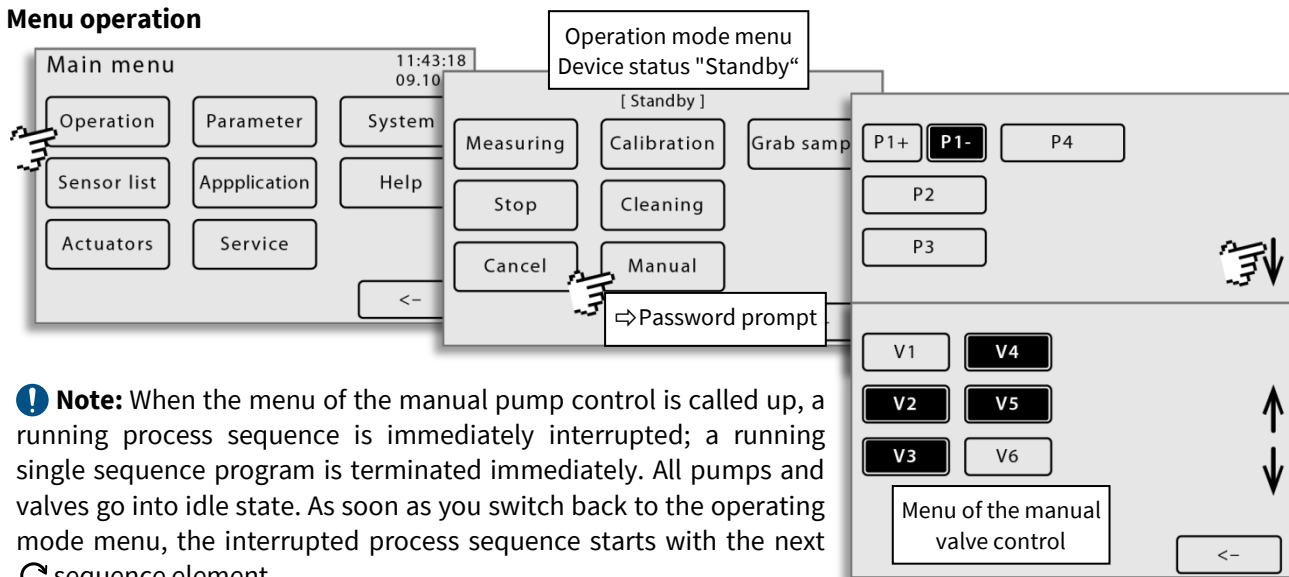

! Note: When the menu of the manual pump control is called up, a running process sequence is immediately interrupted; a running single sequence program is terminated immediately. All pumps and valves go into idle state. As soon as you switch back to the operating mode menu, the interrupted process sequence starts with the next sequence element.

4.3 Test Run

For an optimal functioning of the pumps and the solution flow in the tubing, a test run of the process sequence is recommended.

After the initial filling of all solutions, the process sequence can be started for the test run.

- Start the process sequence with button <Measuring>
The duration of the process sequence is approx. 15 min.

Menu operation

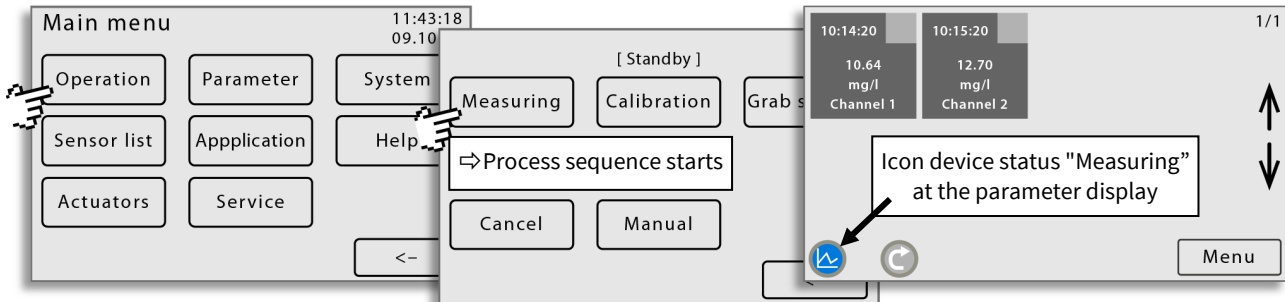

The device activity and the device status of the BlueMon are displayed in the menus: Parameter display 1-way, Parameter display 6-way, Measurement overview, Operating mode menu. There in each case in the middle in the top.

see *Manual BlueMon Menu Operation* there *Appendix D – Display of the Device Activity and the Device Status*

Automatic analysis sequence: The process sequence and the operating parameters of the BlueMon are factory set. The measured values of the sample lines and of the virtual (calculated) sensors* are displayed in the parameter display after their first recording.

* and the possibly connected external CAN-bus sensors

4.4 Calibration

Precondition: The BlueMon is in the device status Standby.

⇒ Display [Standby] in the Operation mode menu (see below)

Procedure: Start the ammonium calibration with the button <Cal NH4>.

- The calibration program starts, the duration of the program is about 30 minutes.
⇒ Display [Cal NH4] in the Operation mode menu (see below)
- Switch back to the operating mode menu by pressing the button  for several times.
- Press the <Stop> button to trigger the sequence stop function.
The calibration program runs to the end.
- Wait until the calibration program is finished. ⇒ Device status Standby

! Note: Do not perform any further operation after the Sequence Stop Function has been triggered (c. see above).

Menu operation

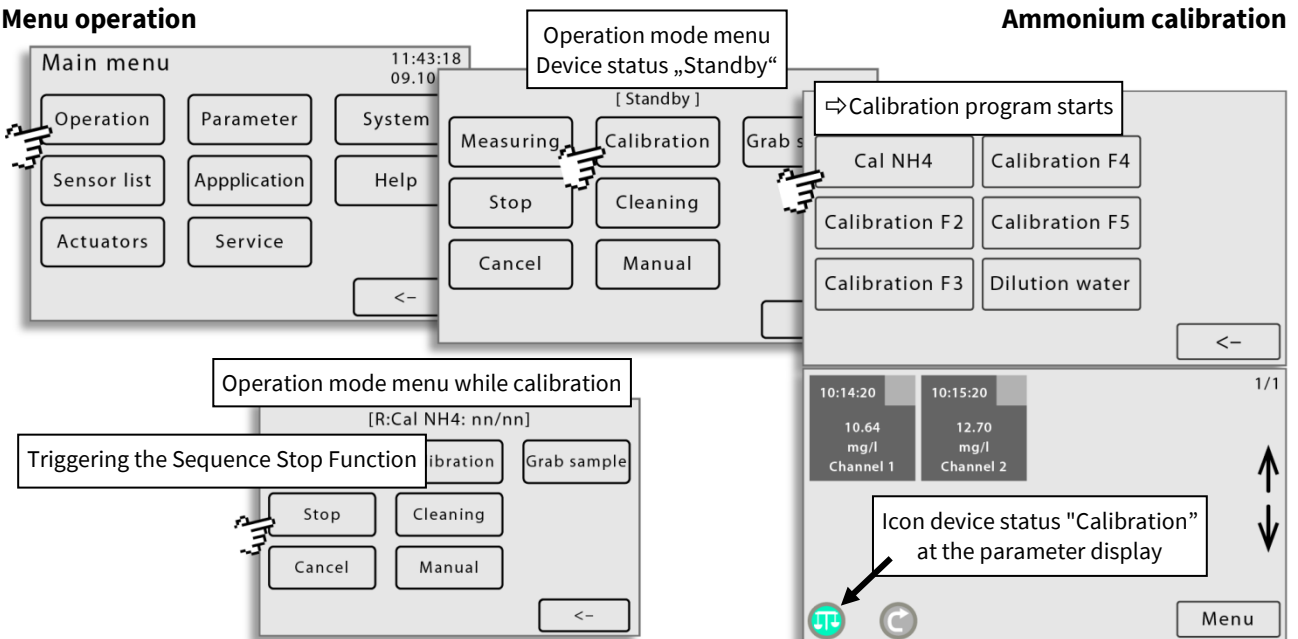

Ammonium calibration

Operation mode menu
Device status „Standby“

⇒ Calibration program starts

Cal NH4 Calibration F4
Calibration F2 Calibration F5
Calibration F3 Dilution water

Operation mode menu while calibration
[R:Cal NH4: nn/nn]

Triggering the Sequence Stop Function

Icon device status "Calibration" at the parameter display

4.5 Operation Start

After the calibration, the process sequence can be started via the operation menu.

- Start the process sequence with the button <Measuring>.
The duration of the process sequence is about 15 minutes.

Menu operation

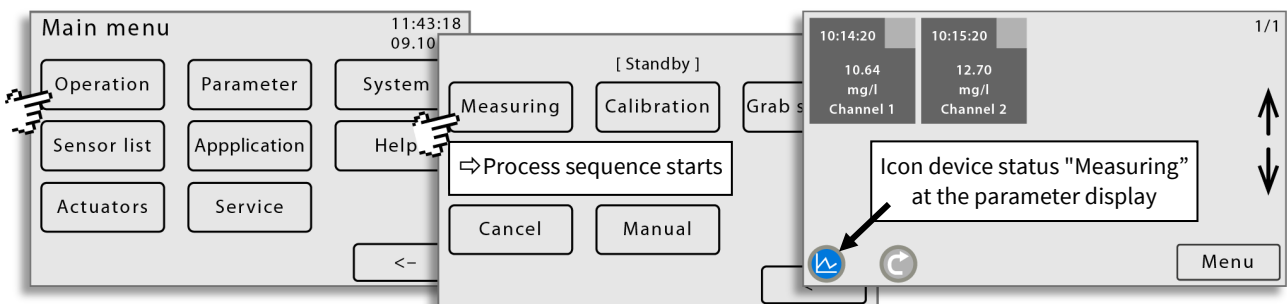

⇒ Process sequence starts

Icon device status "Measuring" at the parameter display

Automatic analysis sequence: The process sequence and the operating parameters of the BlueMon are factory set. In normal operation no changes at the BlueMon is necessary until the next maintenance.

4.6 Notes on the Bubble Detector (Liquid Detector)

The bubble detector detects air bubbles in tubes, i.e. a general lack of liquid. The bubble detector is tested and adjusted on delivery. In certain conditions (e.g. deposits in the tube, exposure to heat, etc.) a reset may be necessary.

- The function lamp lights **orange** if **no bubble** is detected.
- The function lamp lights **red** when **a bubble** is detected.
- The function lamp does **not** light up if **no light** is detected.

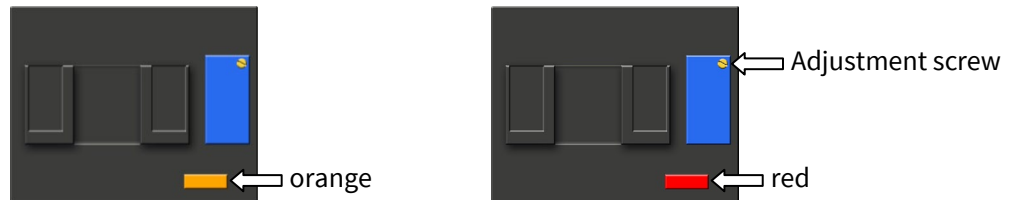

The sensitivity of the bubble detector is adjusted with the adjustment screw (see above) in standby mode. The adjustment screw operates a potentiometer. Turning to the left increases the sensitivity, turning to the right decreases the sensitivity.

The expected maximum rotation angle range is $\pm 45^\circ$, even $\pm 90^\circ$ would be very unusual.*

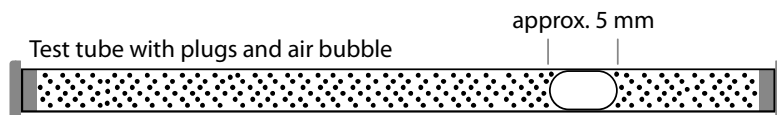

The sensitivity is tested with a test tube: Move the air bubble through the measuring section, if the air bubble is in the measuring path, the function lamp must light red, otherwise orange.

For further information see *Manual BlueMon Menu Operation* there 8.2.5.6 *Liquid Detector*

* Depending on the version of the potentiometer actuated with the adjusting screw, the setting range is 15 to 20 rotations. A slight clicking noise is noticeable when the end stop jumps over. It is not possible to overturn the potentiometer.

5 Decommissioning

If you want to shut down the BlueMon for a long time, proceed as follow:

1. Stop the program sequence with <Menu> Main menu ⇒ <Operation> ⇒ <Stop>
Each running program is executed to the end and the system is then stopped. The system will then go to "Standby" status.
2. Interrupt the supply of chemicals.
3. Immerse the sample tube(s) in DI water.
4. Let the cleaning program run at least 3 times.
5. Remove the tubes of the chemical canisters.
6. Immerse all tubes from the chemical canisters in DI water.
Start with <Menu> Main menu ⇒ <Operation> ⇒ <Manual> all pumps by pushing the appropriate pump button. Flush the BlueMon for about half an hour.
7. Remove the dip tubes from the DI water so that the pumps pump air. Let the pumps pump for as long as necessary until the whole device is completely emptied
8. Leave the pump menu.
9. Turn off the BlueMon by pulling the power plug.
10. If the BlueMon shall be transported, mount the transportation locks.



Note necessary protective measures! see safety data sheet





Observe personal protective measures!

6 Maintenance

 **Danger:** Stop any operation before opening the housing door.

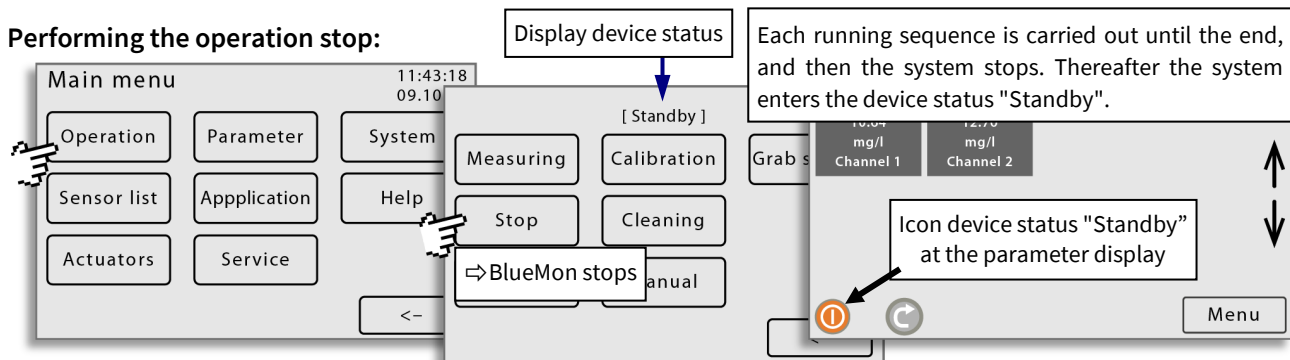
Performing the operation stop:



 **Note necessary protective measures! see safety data sheet**

 **Observe personal protective measures!**

6.1 Changing Chemicals

You will receive the necessary reagents and calibration liquids (see 2.12) from GO Systemelektronik. To change the chemicals you have to stop the process sequence and replace the chemicals canisters after the BlueMon had stopped.

After a successful change, feed the chemicals manually (as in 4.2 Initial Filling).

After a reagent change, a calibration is required.

6.2 Changing Tubes and Tube Connectors

You need the consumables set (see 2.10) from GO Systemelektronik.

Before changing tubes and tube connectors, put all suction tubing in DI water. Start the cleaning sequence via <Menu> Main menu ⇒ <Operation> ⇒ <Cleaning>.

At the end of the cleaning program, remove the tubes from the DI water.

Start via <Menu> Main menu ⇒ <Operation> ⇒ <Manual> all pumps so that air is pumped. Let the pumps pump until the entire unit is completely drained. Tube changing at pump head see 7

6.3 Cleaning (manual)

GO Systemelektronik recommends regular cleaning of the BlueMon. Cleaning must be carried out at the latest after underrunning/overrunning of the minimum/maximum values of the calibration factors.

To remove reaction residues, you can use cleaning liquid (min. 100 ml) and feed it via the sample feeder.

After a residence time of 30 minutes of the cleaning liquid, the system must be emptied via the drain valves. Then repeat this procedure with DI water to rinse the system.

6.4 Maintenance Intervals

- Change reagents every 3 months
- Replace tubing every 6 months

6.5 Notes on the Sample Heating

 **Warning:** There may be aggressive and hot liquids in the sample heating. Make sure that the sample heating is emptied and cooled down during maintenance.

7 Tube Changing at the Pump Head



Note necessary protective measures! see safety data sheet
Warning: Only perform this when the pump is not running.
 Preparation according to 6.2 *Changing Tubes and Tube Connectors*



Observe personal protective measures!

i It is recommended to oil the axles of the pump rollers at each tube changing, see 7.3 *Oiling the Pump Roller Axles*

7.1 Tube Bed Pump

A pump head can be designed for 1 to 3 tubes. The tubes are placed at the rotor with the tube beds.

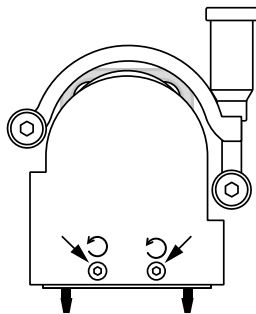
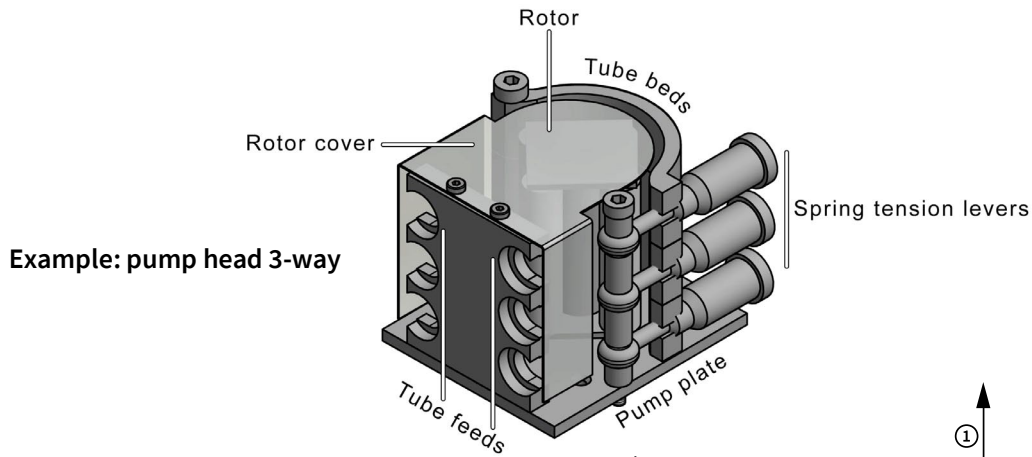

Unfasten the mounting screws (Hex socket \square 2.5 mm) of the rotor cover. Remove the rotor cover.

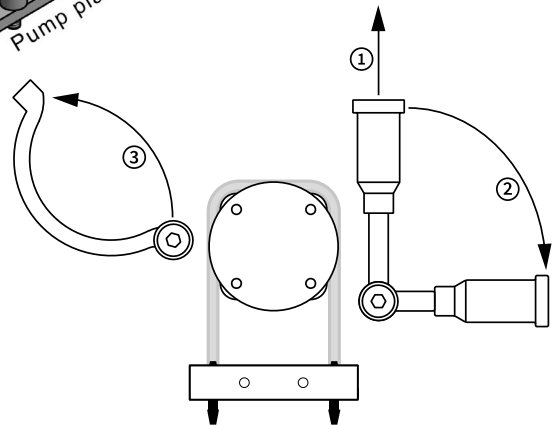

Pull each lever out of the groove of the tube beds (1) and turn the levers to the side (2). Swivel the tube beds to the side (3).

Pull the tube connectors downwards out of the fitting in the tube feed (1) and then turn the tube ends to the side (2). Remove the tubes.

Insert the new tubes in the reverse order.

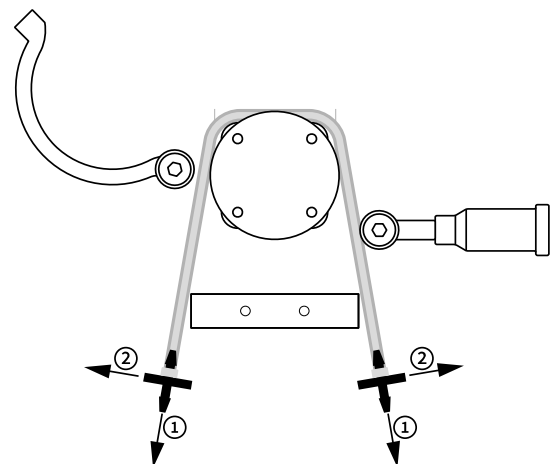

7.2 Cassette Pump

The pump head of a cassette pump can be designed for 1 to 4 tube cassettes. The tubes are placed at the rotor with the tube cassettes.

- ① Press the nose of the tube cassette from above.
- ② Swivel the tube cassette to the left.
- ③ Slide the tube cassette out of the holder to the left.

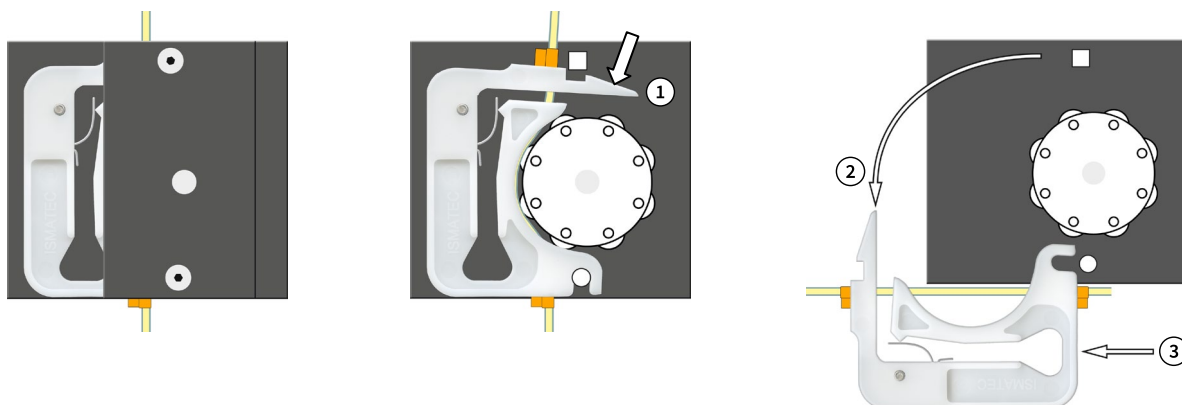
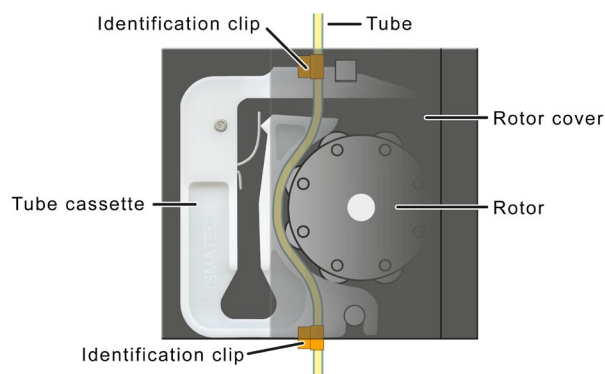

The tube cassette with the pump tube is detached.

- ④ Stretch the elastic tube with the identification clip to the left out of the tube fitting.
- ⑤ Lift and pull the tube out of the tube fitting.

The tube is detached.

Insert the new tube in the reverse order.

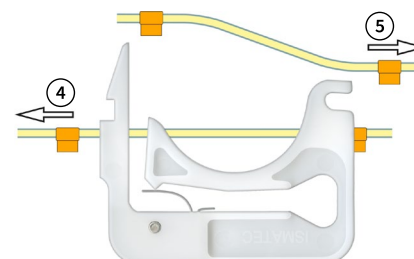

7.3 Oiling the Pump Roller Axles

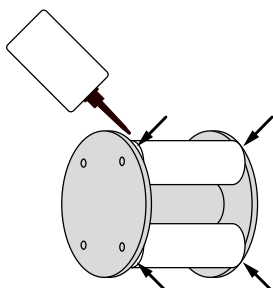

It is recommended to oil the axles of the pump rollers at each tube changing.

Carefully and sparingly apply some sewing machine oil to the area between the circular surfaces of the pump rollers and the pump rotor. Turn the pump rollers to spread the oil.

8 Replacement of the Cuvette on the Photometer and Spectralphotometer

It is usually not necessary to remove and install the glass cuvette, but it may happen that the cuvette is damaged when the cuvette tubes are removed in the course of a tube exchange. It is also possible that the cuvette may have to be removed for cleaning due to unusual sample contamination.



Note necessary protective measures! see safety data sheet

1 Photometer setup

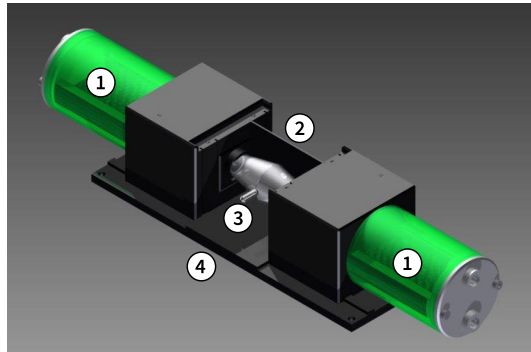

- ① Cuvette holders
- ② Side cover
- ③ Cuvette
- ④ Base plate

2 Preparation

Note: Cleaning should be carried out as required.



Danger: All operation must be stopped before opening the housing door.

Danger: Empty the photometer and the connected components completely.

Performing the operation stop:

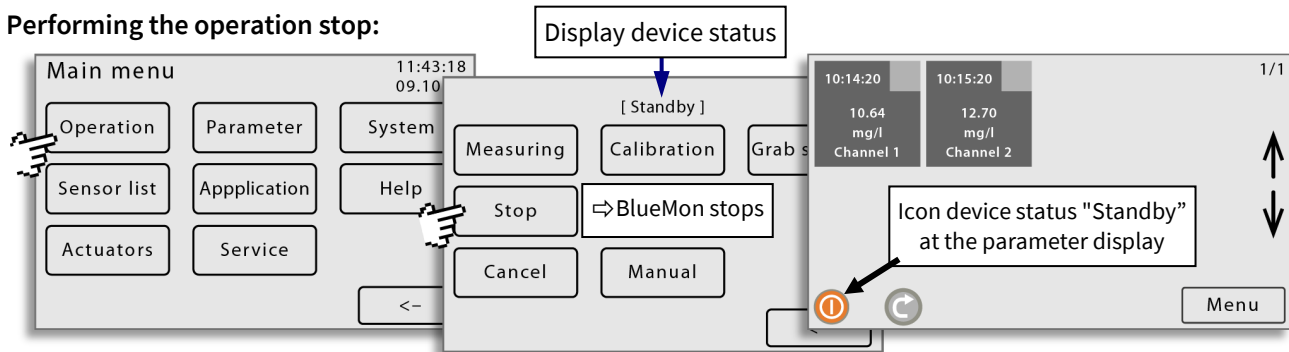

Each running sequence is carried out until the end, and then the system stops. Thereafter the system enters the device status "Standby".

Required tools:

- Hex socket wrench 2.5 mm for the four socket screws of the photometer housing cover
- Hex socket wrench 1.5 mm for the two headless socket screws of the cuvette holders

Remove tube connection:

The photometer is located at the top in the middle on the device plate of the BlueMon analyzer. Remove the connecting tubes from the cuvette tubes.

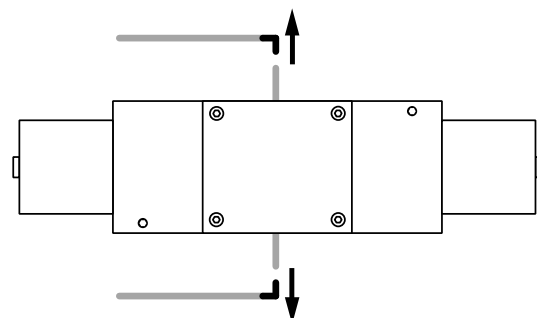

3 Cuvette dismounting

Opening the photometer housing

Use the 2.5 mm hex socket wrench to remove the four hex socket screws of the photometer housing cover. Remove the photometer housing cover.

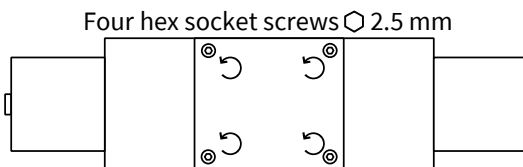

Pull out the cuvette holders: Use the 1.5 mm hex socket wrench to turn each headless hex socket screw one turn to the left. Carefully pull out the cuvette holders until the cuvette is unlocked. Here as an example is the 50 mm barrel cuvette without small cuvette adapters.

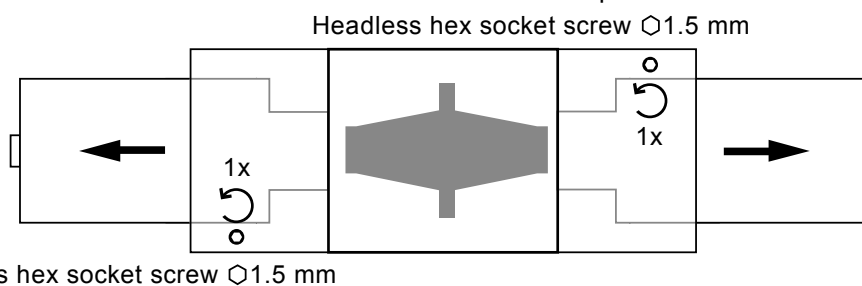

Note: For cuvettes in the size from 1 mm to 5 mm, small cuvette adapter are installed. If necessary, reinstall these after exchanging the cuvettes.

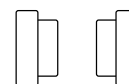

Pull out the cuvette with the two side covers:

Pull out the cuvette with the cuvette tubes and side covers. Carefully ⚠ separate the cuvette, the tubes and the side covers.

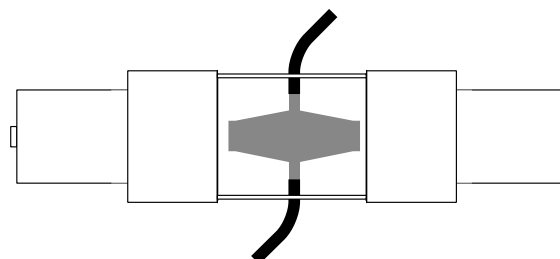

Note that both side covers are not symmetrical!

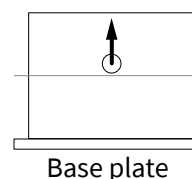

Caution: The properties of the optical surfaces of the cuvette must not be changed, e. g. avoid touching them by hand



Observe personal protective measures!

4 Cuvette mounting

The mounting of the new or cleaned cuvette is done in reverse order to the removal of the cuvette.

Appendix A – Adjustment of the Touch Display

If the display does not respond correctly or only under high pressure, a display adjustment is necessary.

While switching on power, press display until the notice

"touch adjustment ?
don't touch for normal use"
appears.

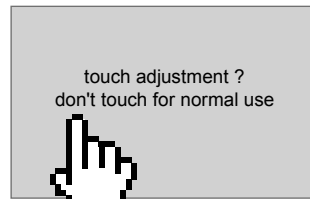
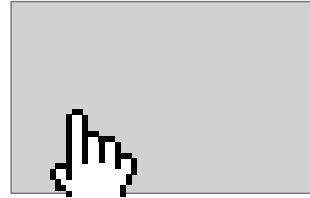

Left off the display immediately!

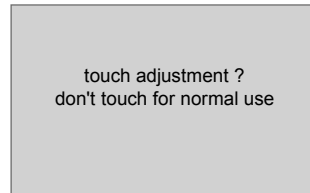

Press the display immediately again for more than one second.

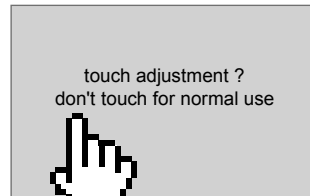

A blinking dot appears at top left.
Press the blinking dot top left.

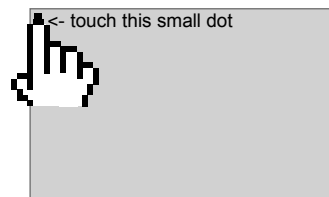

A blinking dot appears at bottom right.
Press the blinking dot bottom right.

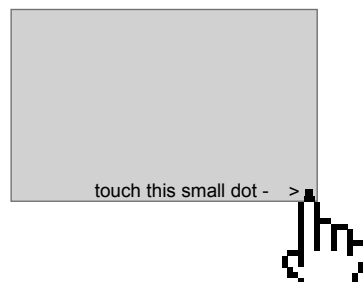



The adjustment is finished.

Appendix B – The Configuration Data Sheet

The configuration data sheet contains the passwords, network addresses etc. necessary for operating the BlueMon.

Example:

 		Configuration Data Sheet Product: BlueMon	Page: 1/1 Date: 2020-04-01
Configured by: Name			
1. BlueMon:			
Serial Number	A1234		
BlueMon Password (PIN)	xxxx		
Storage Device	SST-512		
2. Network:			
IP Address	192.168.1.167		
Netmask	255.255.255.0		
Gateway	0.0.0.0		
Port	14110		
Login Name	bluemon		
Password	xxxxx		
3. BlueGate Settings:			
IP Address	212.51.30.18		
Password BlueGate	xxxxx		
4. BlueMon PC Software - BlueGate Settings:			
Host	datagateway.go-sys.de		
Username	xxxxx		
Password Windows	xxxxx		
This document contains confidential information. © GO Systemelektronik GmbH Faluner Weg 1 D 24109 Kiel Telephone: +49 431 58080-0 Fax: +49 431 58080-11 Internet: www.go-sys.de			

1. BlueMon:

Serial Number	A1234
BlueMon Password (PIN)	xxxxx
Storage Device	SST-512

Serial Number

Serial number of the BlueMon
 With this serial number the BlueMon is identified by the BlueMon PC Software.
 ⇒ set at the factory, not changeable

BlueMon Password (PIN)

Password of the BlueMon
 Is required to change the BlueMon system settings.
 ⇒ set at the factory, not changeable

Storage Device

Model and size of the internal BlueMon memory, here SST-512 (SST= SST NANDrive™; 512=512MB)
 ⇒ set at the factory, changeable by replacing

2. Network:

IP Address	192.168.1.167
Netmask	255.255.255.0
Gateway	0.0.0.0
Port	14110
Login Name	bluemon
Password	xxxxx

IP Address IP address of the BlueMon
At this address, the BlueMon is addressed on the network.
⇒ set at the factory, changeable

Netmask Netmask of the BlueMon
⇒ set at the factory, changeable

Gateway Standard gateway of the BlueMon
⇒ set at the factory, changeable

Port Default gateway of the BlueMon
⇒ set at the factory, not changeable

Login Name User name for a modem connection
⇒ set at the factory, not changeable

Password Network password of the BlueMon
Is needed to access the BlueMon via the BlueMon PC Software.
⇒ set at the factory, not changeable

3. BlueGate Settings:

IP Address	212.51.30.18 ¹
Password BlueGate	xxxxx

IP Address IP address of an Internet Gateway
⇒ can be configured at the factory, changeable²

Password BlueGate Password of an Internet Gateway
⇒ can be configured at the factory, changeable

4. BlueMon PC Software – BlueGate Settings:

Host	datagateway.go-sys.de
Username	xxxxx
Password Windows	xxxxx

If the BlueMon is accessed via a gateway (e.g. with an UMTS connection), you have to enter these access data in the BlueMon PC Software.

¹ IP address of the GO webserver (default address)

² changeable only at the default address

BlueMon Ammonium 2FA0 Commissioning and Maintenance

Appendix C – Maintenance Protocol

Ammonium
 Chlorine
 Fluoride
 Nitrate
 Phosphate

Month/Year _____

Measurement component: _____

Measurement range: _____

Device in operation since: _____

Performed maintenance works:

Daily					Weekly
Date	Time	Visual inspection	Remark	Signature	
		<input type="checkbox"/> OK			<input type="checkbox"/> Reagent stock OK <input type="checkbox"/> Leakage detector checked
		<input type="checkbox"/> OK			
		<input type="checkbox"/> OK			Date: Signature:
		<input type="checkbox"/> OK			
		<input type="checkbox"/> OK			Reagent stock OK Leakage detector checked
		<input type="checkbox"/> OK			
		<input type="checkbox"/> OK			Date: Signature:
		<input type="checkbox"/> OK			
		<input type="checkbox"/> OK			Reagent stock OK Leakage detector checked
		<input type="checkbox"/> OK			
		<input type="checkbox"/> OK			Date: Signature:
		<input type="checkbox"/> OK			
		<input type="checkbox"/> OK			Reagent stock OK Leakage detector checked
		<input type="checkbox"/> OK			
		<input type="checkbox"/> OK			Date: Signature:
		<input type="checkbox"/> OK			

Every three months	Every six months
<input type="checkbox"/> Valves checked <input type="checkbox"/> Hose holder checked <input type="checkbox"/> Hose system, cuvette/measurement cell checked <input type="checkbox"/> Calibration factors checked <input type="checkbox"/> Electrodes (if existing) checked <input type="checkbox"/> Chemicals changed <input type="checkbox"/> Multi pump hoses shifted Date: Signature:	<input type="checkbox"/> Hoses renewed Date: Signature:
	Annual
	GO Systemelektronik service personnel: <input type="checkbox"/> Cuvette cleaned <input type="checkbox"/> Electrodes (if existing) maintained <input type="checkbox"/> Seals and O-rings renewed Date: Signature:

Appendix D – Connection Diagram of the Mainboard

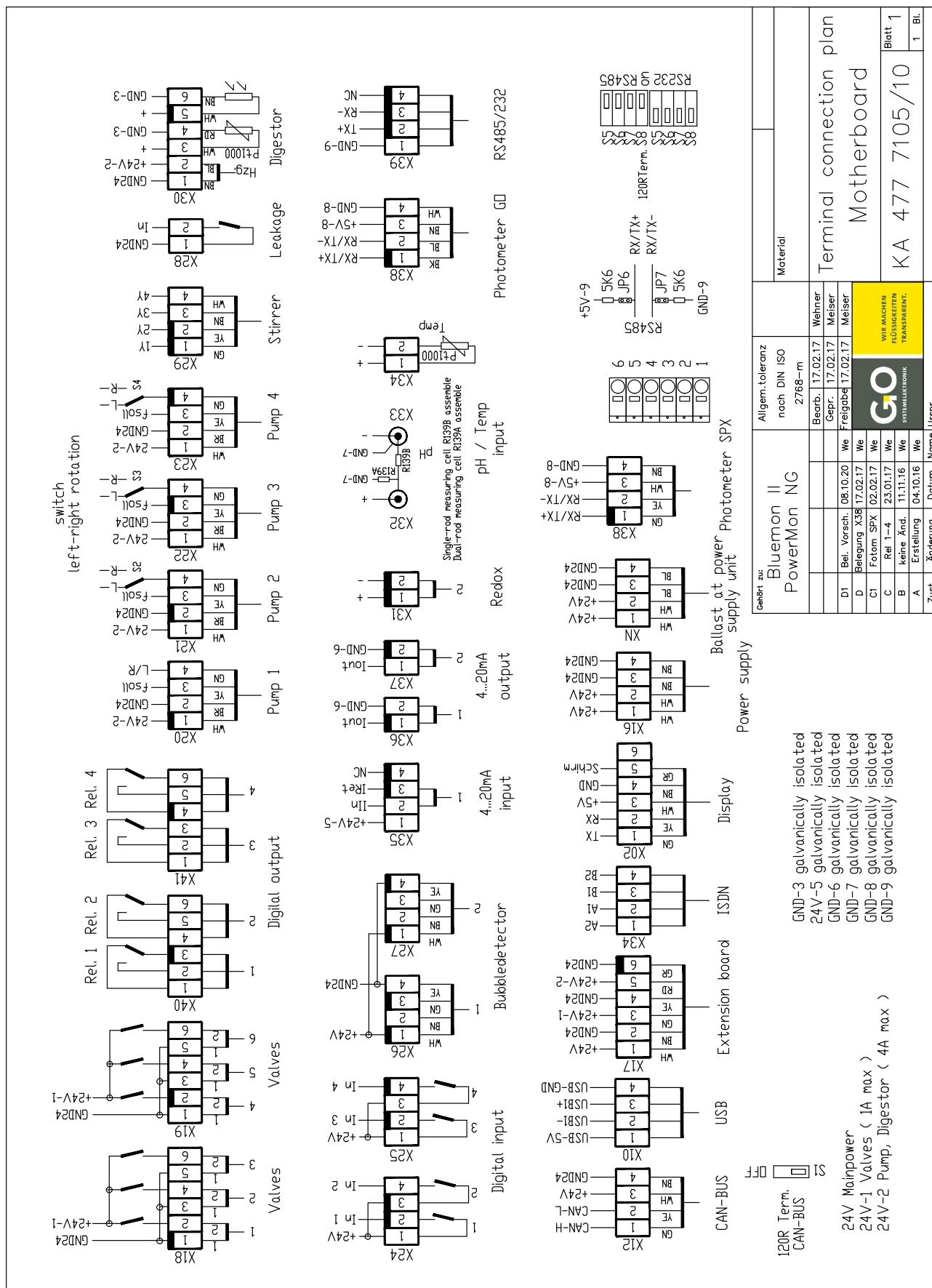

Appendix E – Connection Diagram of the Plug-on Board (optional)

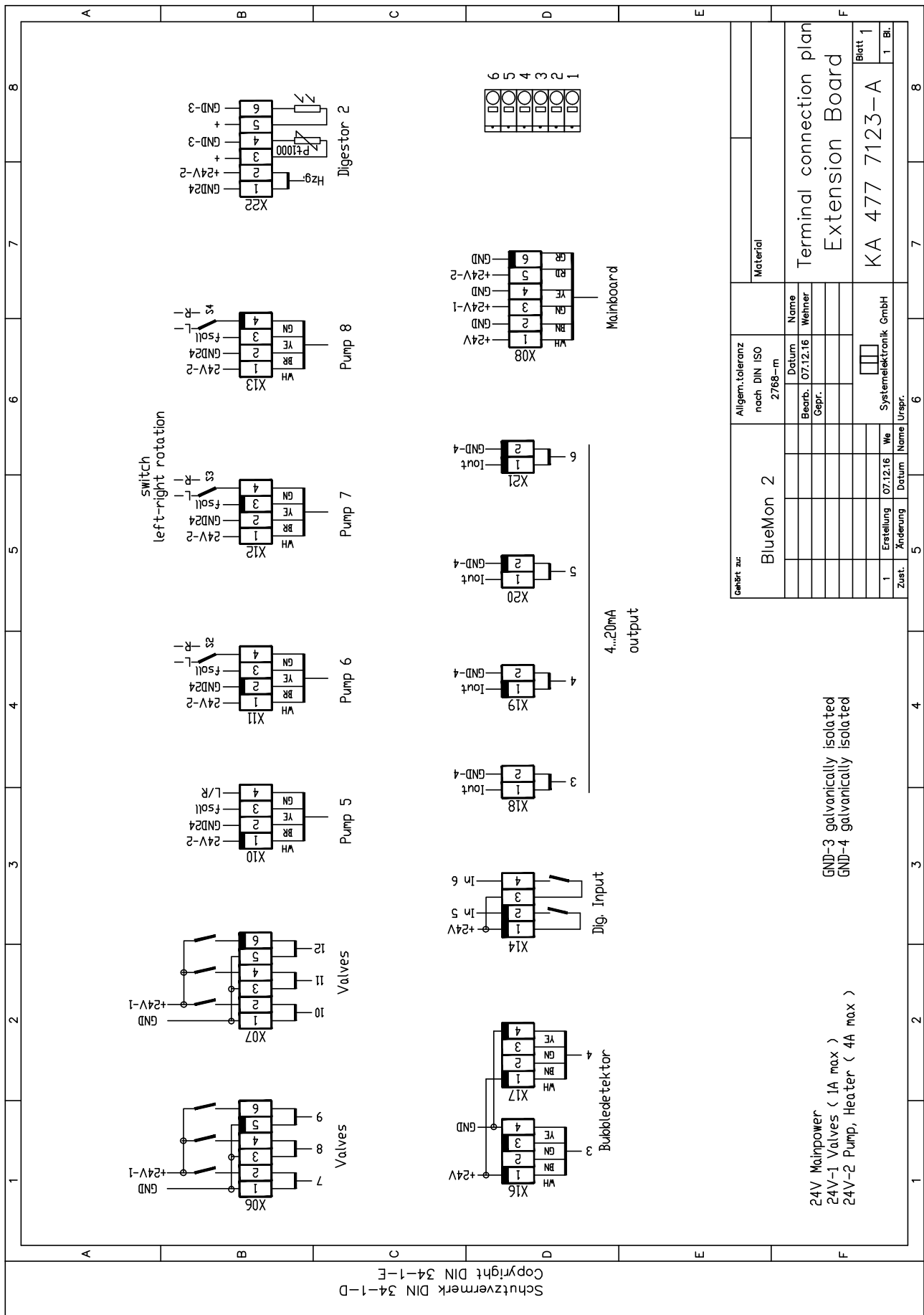

Appendix F – Configuration of the Mainboard

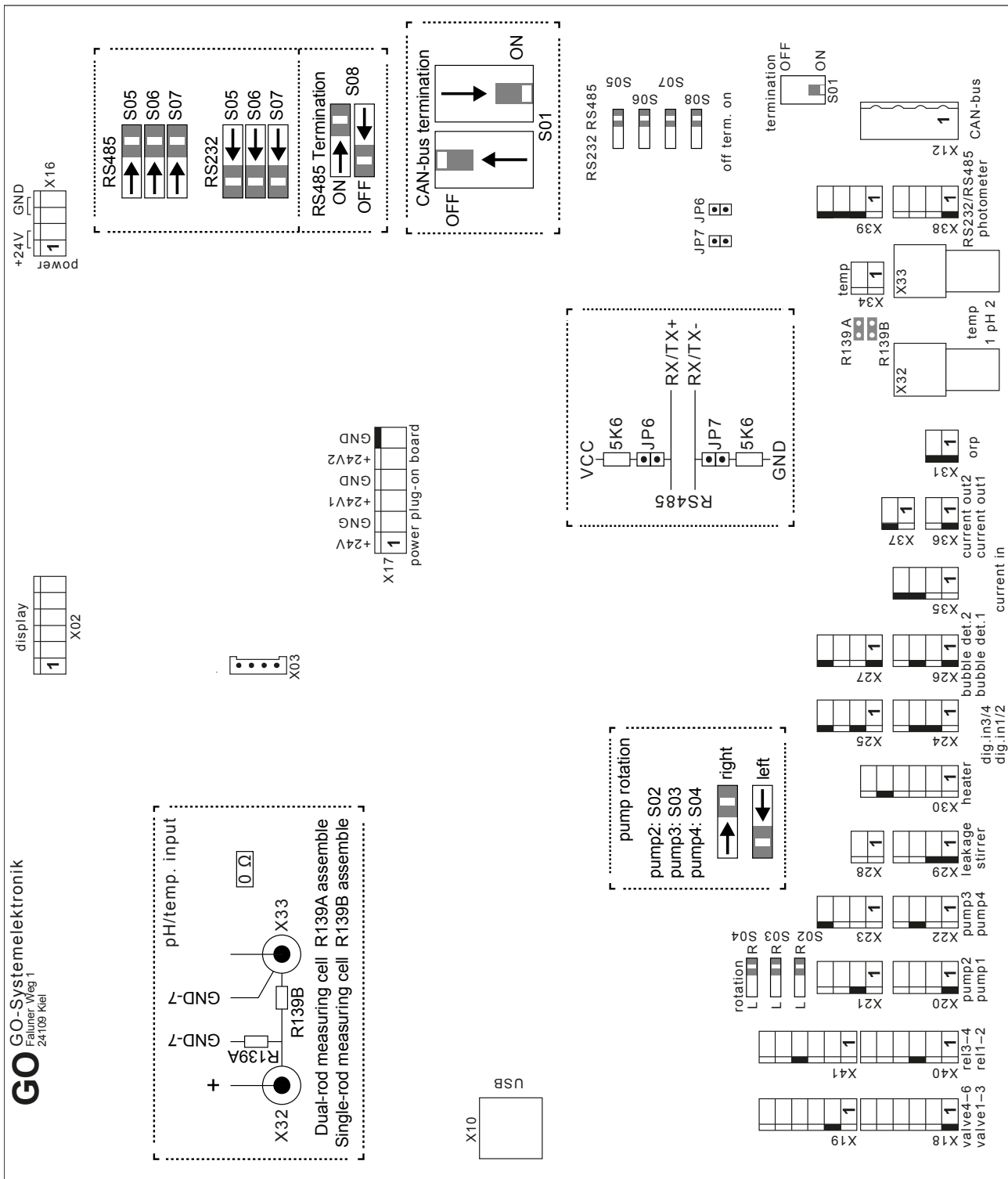

Appendix G – Connection Diagram of the Current Outputs

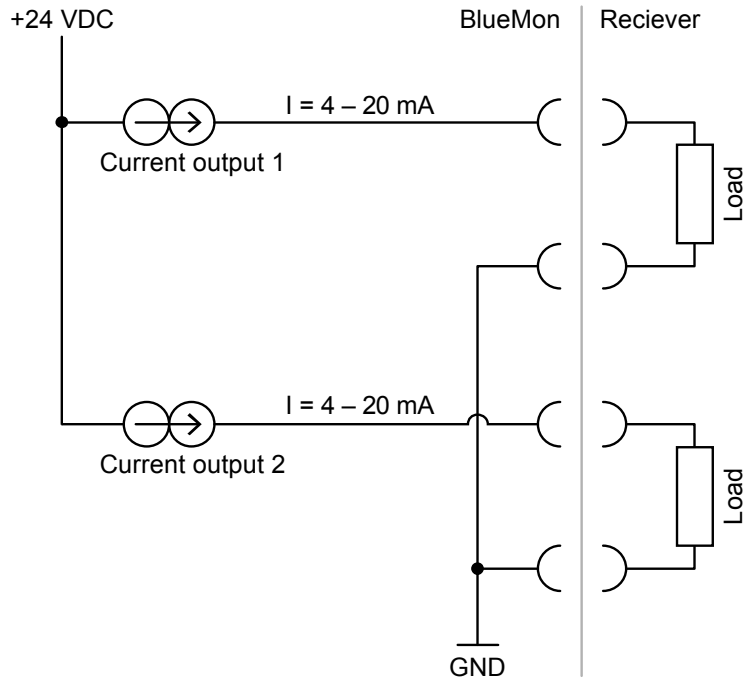

! **Note:** In difference to the BlueBox* the two current outputs of the BlueMon are galvanically isolated from the other connections, but not from each other.

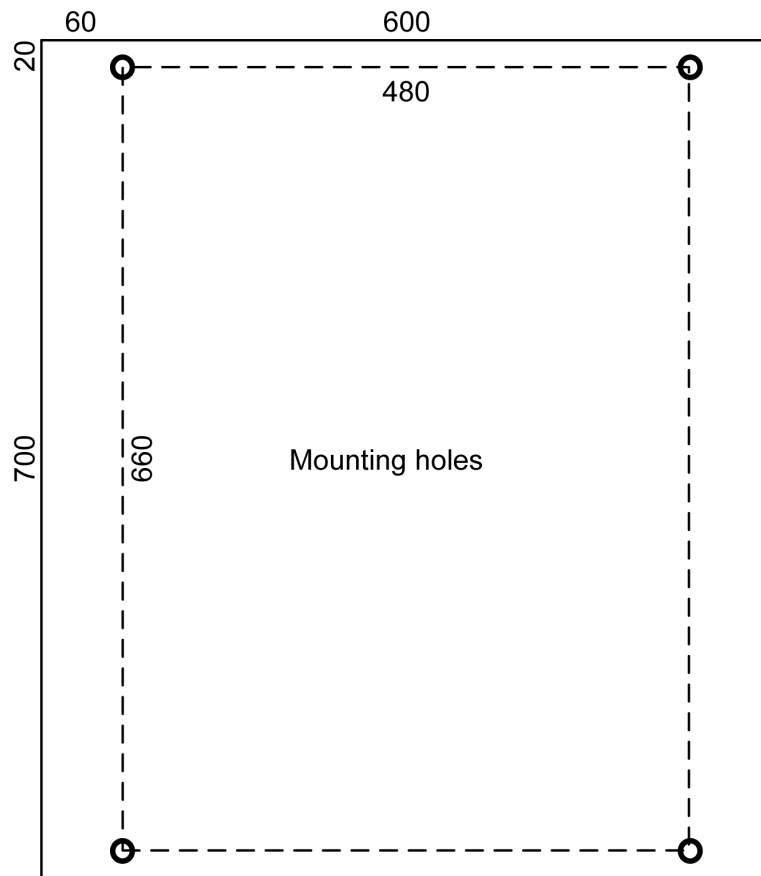

* The BlueBox from GO Systemelektronik is the central element of the BlueBox system. The BlueBox system is a modular measurement and control system.

Appendix H – Device Mounting (large housing)

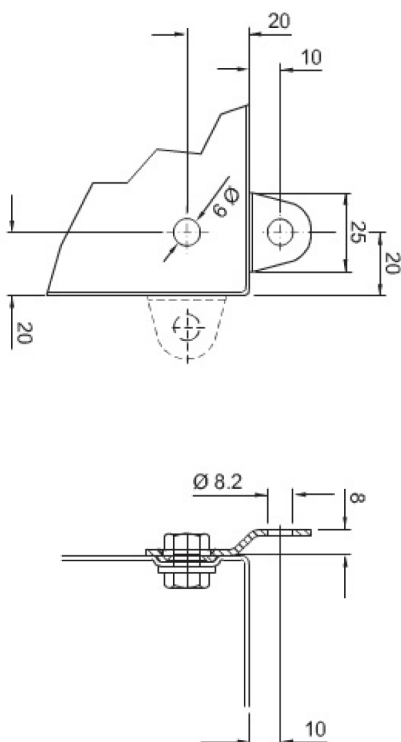

In each mounting hole a rotatable wall bracket is screwed.

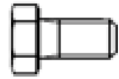

- (1) 4x 
- (2) 4x  M8x16
- (5) 4x  8

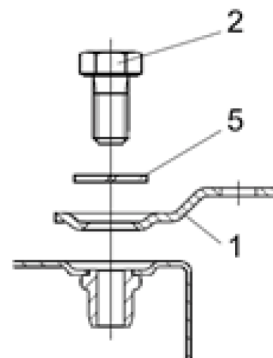

All dimensions in mm

Appendix I – EU Declaration of Conformity



**EU-Konformitätserklärung
EU Declaration of Conformity**

Hersteller: GO Systemelektronik GmbH
Manufacturer: Faluner Weg 1
 24109 Kiel Germany

Die alleinige Verantwortung für die Ausstellung dieser Konformitätserklärung trägt der Hersteller.
 The sole responsibility for issuing this EU declaration of conformity is carried by the manufacturer.

Gegenstand dieser Erklärung: BlueMon Analysator
Subject to this declaration: BlueMon Analyser

Artikelnummer: 488 XXXX
Article No.:

Typenschild des Produktes:
Type plate of the product:

Type : BlueMon xxxxxxxx	CE
GO Systemelektronik Art. No.: 488 XXXX	
Ident.Article No.: 488 XXXX	
Serial Number: BMXXXX	

Der oben beschriebene Gegenstand der Erklärung erfüllt die einschlägigen Harmonisierungsvorschriften der Union.
 The subject matter described above fulfills the relevant harmonization rules of the Union.

Zugrunde liegende harmonisierte Normen:
Underlying harmonized standards:

- | | | |
|--------------------------|----------------|-------------------------|
| 1. DIN EN 61000-6-3:2011 | Störaussendung | Interference emission |
| 2. DIN EN 61000-6-1:2007 | Störfestigkeit | Interference resistance |

(Falls zutreffend) **Gemäß den Bestimmungen der Richtlinie/den Dokumenten:**
 (If applicable) **Following the provision of directive/the documents:**

- | | | |
|---|---------------------------|-----------------------|
| 1. DIN EN 62368-1 | Niederspannungsrichtlinie | Low voltage directive |
| 2. Fertigungsanleitung BlueMon Analysator | 488 XXXX | |
| Manufacturing instruction BlueMon Analyser | 488 XXXX | |
| 3. Fertigungsanleitung Aufbau, Verdrahtung und Verschlauchung incl. Grundbestückung | 442 0060 | |
| Manufacturing instruction, assembly, wiring and tubing incl. basic equipping | 442 0060 | |
| 4. Prüfanleitung BlueMon Analysator | QM 50 5110 | |
| Test instruction BlueMon Analyser | QM 50 5110 | |
| 5. Bedienungsanleitung BlueMon Inbetriebnahme und Wartung | | |
| Manual BlueMon Commissioning and Maintenance | | |

Kiel, 4.3.2022
 Ort, Datum der Ausstellung
 Place, date of issue

 Dr. Thorsten Knutz
 Geschäftsführer Managing director

GO Systemelektronik GmbH Faluner Weg 1 24109 Kiel Germany Tel.: +49 431 58080-0 Fax: -58080-11
 www.go-sys.de info@go-sys.de Seite Page 1 / 1