

# Manual

## ISA and Process Spectrometer with BlueScan Spectrometer



### Commissioning – Maintenance – Service



## Copyright

According to the protective notes of DIN ISO 16016

"The reproduction, distribution and utilization of this document as well as the communication of its contents to others without express authorization are prohibited. Offenders will be held liable for the payment of damages. All rights reserved in the event of patent, utility model or design registration."

## Changes

GO Systemelektronik GmbH retains the right to modify the contents of the manual without prior notice.

## Liability exclusion

GO Systemelektronik GmbH takes no responsibility for correct system operation under all possible operating conditions. It is not possible to guarantee that the software will function completely without error under all possible circumstances. GO Systemelektronik GmbH therefore disclaims all liability for any direct or indirect damage resulting from system operation or the contents of this manual.

## Product observance

Within the scope of our obligation for product observance GO Systemelektronik GmbH will endeavour to warn third parties about all identified dangers which could arise from the interaction between hardware and software and from the use of other components. Effective product observance is only possible with adequate information from the end user about the planned field of application and the hardware and software used. If the conditions of use change or if the hardware or software is changed, due to the complex relationships between hardware and software, it is no longer possible to describe all possible dangers and their effects on the total system, in particular on our system. This manual does not describe every possible property and combination of the system. For further information, please contact GO Systemelektronik GmbH.

## Manufacturer's declaration

When installing the system, it is necessary to ensure correct electrical connection, protection against moisture and foreign bodies and excessive condensation, and system heating which can arise from both correct and incorrect use. It is the responsibility of the installer to ensure that the correct installation conditions are provided.

## Meaning of the Safety Instructions



**Danger:** Used if non-observance threatens serious injury or death.



**Warning:** Used if non-observance threatens slight injuries or serious property damage.



**Caution:** Used if non-observance threatens minor property damage.



Symbol of safety instruction relating to the use of electricity.



Symbol of safety instruction relating to the ATEX directive.

## Notes on Compressed Air Cleaning

For spectrometers with compressed air cleaning, it makes sense to use this in most applications. The compressed air line has to be connected to the designated plug connection of the BlueBox or the sensor module.

**!** Use only oil-free compressors.

The air consumption of the compressed air cleaning depends on the supply-pressure (4 – 6 bar) and the counter-pressure in the medium. At 6 bar supply-pressure the air consumption is maximum 1 litre per second.

**Example:** With an interval of 60 seconds and a cleaning time of 5 seconds the maximum air consumption is 300 litres per hour.

## General Notes on Using Touchscreens

Careful handling of touchscreens is important for their service life and function.

- Avoid excessive mechanical pressure.
- Only operate the display with your fingers or suitable pens, and not with sharp or hard objects.
- Avoid temperatures above 70 °C.
- Avoid frost.

## Cleaning the Display



Clean the display with a commercially available glass cleaner and a soft cloth.

## Notes on the Compatibility of Older and Newer Spectrometers

There are three generations of ISA Spectrometers.

- **First generation**

The CAN ID begins with isa in small letters, e.g. isa00001. Hardware: BlueBox TS and external Spectrometer Module with Article-No. 486 6002 or 486 6004.

- **Second generation**

The CAN ID begins with ISA in capital letters, e.g. ISA00001, and the firmware version of the spectrometer electronics is < 5.00.

The firmware version of the spectrometer electronics is displayed as **AVRDAM** at the bottom right of the spectrometer's sensor setup window.

Hardware: BlueBox TS and external Spectrometer Module with Article-No. 486 6002 or 486 6004

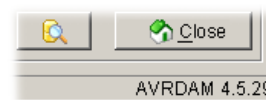

- **Third and current generation**

The CAN ID begins with ISA in capital letters, e.g. ISA00001, and the firmware version of the spectrometer electronics is ≥ 5.00.<sup>1</sup>

The firmware version of the spectrometer electronics is displayed as **ARMDAM** at the bottom right of the spectrometer's sensor setup window.

Hardware: BlueBox RS and external spectrometer module with Article-No. 486 6000.

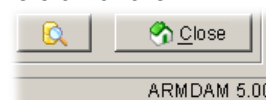

### Spectrometers of the second and third generation are largely compatible.

⇒ Third generation spectrometers on BlueBox T4/TS are compatible with BlueBox firmware version ≥ 4.05.29 with minor restrictions<sup>2</sup> in menu operation.

### BlueBox PC Software

⇒ The BlueBox PC Software is compatible with older hardware

⇒ Utilisation of the full functionality of third generation spectrometers on BlueBox R1, RP and RS with the BlueBox PC Software with software version ≥ 5.0.

For more information, please contact GO Systemelektronik.

**Software version of the BlueBox PC Software:** The lead version of the BlueBox PC Software is the version of the AMS program. The AMS program is part of the BlueBox PC Software.

Query the software version of your BlueBox PC Software in AMS:

Call up in the AMS start window under Help>About

The software version of the BlueBox PC Software in this example is 5.0.

The information after the second full stop is for internal purposes.

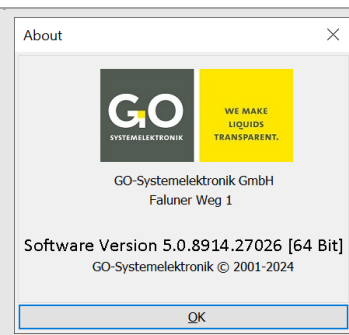

<sup>1</sup> in addition, the serial number on the label on the spectrometer board is ≥ 1800

<sup>2</sup> In the T4/TS menu operation, the light power setting of the flash lamp and the entry of a validity limit for the SQL are missing.

Display Adjustment BlueBox T4 TS

**i** If the display does not respond correctly or only under high pressure, a display adjustment is necessary: While switching on the power supply, press the display until the display shows "touch adjustment ? don't touch for normal use" appears.

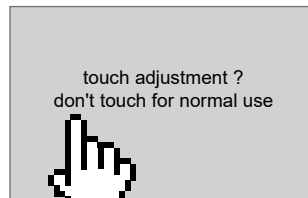
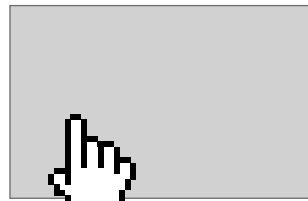

Left off the display immediately!

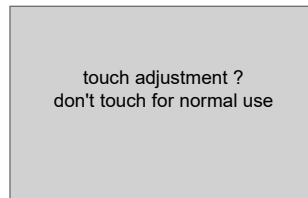

Press the display immediately again for more than one second.

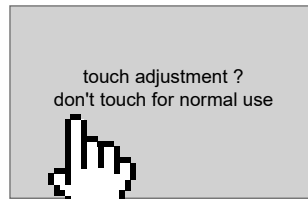

A blinking dot appears at top left. Press the blinking dot top left.

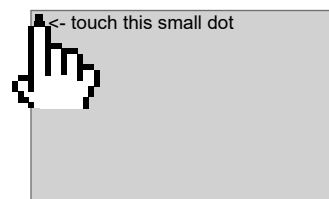

A blinking dot appears at bottom right. Press the blinking dot bottom right.

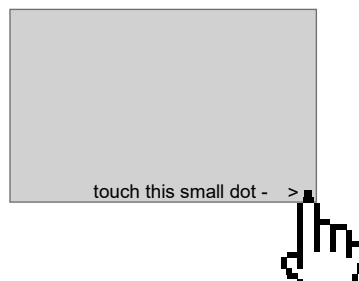

The adjustment is finished.

## Table of contents

Meaning of the Safety Instructions.....	3
Notes on Compressed Air Cleaning .....	3
General Notes on Using Touchscreens.....	3
Cleaning the Display.....	3
Notes on the Compatibility of Older and Newer Spectrometers .....	4
Display Adjustment BlueBox T4 TS.....	5
1 ISA Overview.....	8
1.1 Specifics Sensor Head ISA-SDU .....	8
2 ATEX Notes.....	9
3 Commissioning and Operation Notes .....	9
3.1 Safety Notes.....	10
4 Commissioning .....	11
4.1 Initial Cleaning of the two Glass Panes of the Measurement Path.....	11
4.2 Base Calibration.....	12
4.2.1 Work Flow of the Base Calibration .....	12
4.2.2 Flow Chart of the Base Calibration .....	13
4.2.3 Setting the Measurement Path Length .....	14
4.2.4 Setting the Intensity (Light Intensity).....	15
4.2.4.1 Setting the Intensity at the BlueBox Display.....	15
4.2.4.2 Setting the Intensity with the program AMS .....	17
4.2.5 Intensity Calibration (Light Intensity) with the program AMS.....	19
4.2.6 Clear Water Calibration .....	21
4.2.6.1 Clear Water Calibration at the BlueBox Display.....	21
4.2.6.2 Clear Water Calibration with the program AMS .....	23
4.2.6.3 Messages of the Clear Water Calibration at BlueBox T4 and BlueBox TS.....	25
4.2.7 Guided Commissioning at the BlueBox R1 and BlueBox RS Display.....	26
4.2.7.1 Guided Base Calibration Procedure .....	27
4.3 Application-Specific Calibration .....	28
4.3.1 Overview Application-Specific Calibration .....	29
4.3.2 Flow Chart of the Application-Specific Calibration .....	30
4.3.3 Recording of Test Series.....	31
4.3.4 Creating a Calibration Table.....	31
4.3.5 Application example of TOC/COD in process water .....	32
4.4 Reference Measurement at the BlueBox R1 and BlueBox RS Display .....	35
4.4.1 Call-Up at Calibration Start Display.....	35
4.4.2 Sample Table.....	35
4.4.3 Reference Measurement .....	36
4.4.4 Sampling with the Last Captured Spectrum .....	36
4.4.5 Add Sample via Date and Time of the Measurement Recording.....	37
4.4.6 Edit Sample.....	37

5 Maintenance .....	38
5.1 Maintenance Notes .....	38
5.2 Maintenance Recommendations .....	38
5.3 Cleaning the Sensor Head .....	39
5.3.1 Work Flow of the Cleaning .....	40
6 Factory Service.....	41
7 Process Spectrometer (Flow Through Unit) Overview .....	42
7.1 Commissioning and Base Calibration .....	42
7.2 Maintenance.....	43
7.2.1 Maintenance Recommendations .....	43
7.2.2 Cleaning the Process Spectrometer.....	44
7.2.2.1 Cleaning without Dismounting the Spectrometer Optic.....	44
7.2.2.2 Cleaning with Dismounting the Spectrometer Optic.....	45
7.3 Factory Service.....	47
8 BlueScan .....	48
8.1 Setting the Measurement Gap Length.....	49
Appendix - ISA Parameter Calculation .....	50

## Note on Text References

References to passages in this document or to passages in other documents are marked in italics.

- *4.2 Base Calibrations* e.g. refers to the section 4.2 in this document.  
The short form is *4.2*.
- *Manual BlueBox PC Software* there *5 AMS - Advanced Managing Software* e.g. refers to the chapter 5 in the Manual BlueBox PC Software.

## 1 ISA Overview

This part of this manual describes the Commissioning, Maintenance and Service of the ISA Spectrometer of GO Systemelektronik.

The ISA Spectrometer with its in situ submersible sensor head is available in three versions:

- **ISA RS TS** BlueBox RS and TS with integrated spectrometer sensor unit<sup>1</sup>
- **ISA R1 T4** BlueBox R1 and T4 with one or more external spectrometer modules
- **ISA mobile** ISA TS with two accumulator batteries and a power up control module (Power Management Module PMM) integrated in a suitcase

The sensor head is available in two versions:

- **Sensor head ISA** Article No. 461 6002 The measurement path is steplessly adjustable from 0.5 to 20 mm with a screw thread. The measuring head has an integrated compressed air cleaning.
- **Sensor ISA-SDU** Article No. 461 6010 The measurement path is steplessly adjustable from 0.5 to 20 mm with a screw thread. The sensor head is mounted in a flow-through housing with integrated cleaning wiper and has no compressed air cleaning. see 1.1 Specifics Sensor Head ISA SDU

The operation performs at the display of the BlueBox and with the BlueBox PC Software<sup>2</sup>.

**i Note:** For a complete description of the operation of the ISA Spectrometer, see *Manual ISA Spectrometer*.

The products of GO Systemelektronik are constantly being developed, therefore deviations between this manual and the delivered product can result. Please understand that no legal claims can be derived from the contents of this manual.

### 1.1 Specifics Sensor Head ISA-SDU

Article No. 461 6010

- The sensor head of the SDU version has no compressed air cleaning; the sensor head cable has no compressed air line and is therefore more flexible.



- The standard cable of the SDU sensor head has a length of 1 m, others on request.
- The SDU sensor head is mounted in a flow through fitting with integrated cleaning wiper.
- The SDU sensor head is designed for operation with a cleaning wiper.
- The measurement path is continuously adjustable from 0.5 to 20 mm with a screw thread. The SDU sensor head has a mechanical-stop on each side of the measurement path.

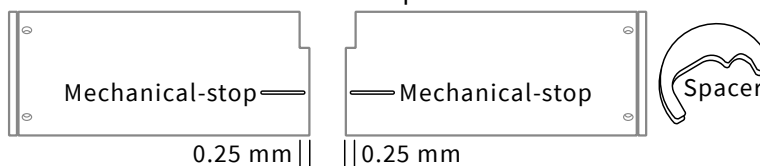

The minimum measurement path length is therefore 0.5 mm.

- **i** The wiper thickness must match the gap of the measurement path. The standard range of the gap width is 0.5 to 5 mm. Enclosed there are two spacers with 0.5 mm and 1 mm thickness, others on request.

<sup>1</sup> Further sensor units can be connected with external sensor modules via the CAN-bus interface.

<sup>2</sup> especially with the software AMS



## 2 ATEX Notes

These ATEX notes only apply to the ISA R1 version with the sensor head ISA at a Spectrometer Module.

Guideline 2014/34/EU, known as the ATEX directive of the European Union, requires in Annex II to the fulfilment of basic safety requirements for devices that are provided within the EU for use in potentially explosive atmospheres.



The sensor head of the spectrometer has the following ATEX-characterisation:  
 II 3/- G Ex op is IIA T4 Gc/-

A version with ATEX category 2 is available on request; further details on request from GO Systemelektronik.



When using the GO cleaning wiper (Article-No. 462 SW00) on the sensor head ISA the ATEX directive is no longer fulfilled



**Danger:** The spectrometer module must absolutely be located outside the explosion-endangered area.



**Warning:** The supply voltage must not be applied to the housing of the spectrometer module; the housing of the spectrometer module must always be earthed.



**Danger:** The electrical resistance between the lower eyebolt of the sensor head and the earthing screw of the spectrometer module must be less than 50 Ω.

Parameter:

Electrical data:	maximal input voltage of the sensor module:	28 VDC
Range of ambient temperature:	Sensor head:	0 °C to +110 °C
	Sensor module:	0 °C to +40 °C

Special conditions for safe use:

- The ambient temperature of the sensor is 0 °C to +110 °C.
- The sensor module must be installed outside of explosion-endangered areas.
- The ambient temperature of the sensor module is 0 °C to +40 °C.

The basic safety and health requirements are fulfilled by compliance with:

- DIN EN 60079-0:2014-06 General requirements
- DIN EN 60079-28:2016-04 Optical Radiation 'op is'



Identification of the sensor head:  
Laser engraving

**ISA GO** WE MAKE LIQUIDS TRANSPARENT.

In Situ Spectral Analyser

Article No.: 461 6002

Temp.: 0 °C - 110 °C MTL: 1.4404

 II 3/- G Ex op is IIA T4 Gc/-

 0158 BVS 11 ATEX E 036 X

GO Systemelektronik GmbH Faluner Weg 1  
24109 Kiel Germany www.go-sys.de

Identification of the spectrometer module:  
abrasion resistant label on the outside right



**GO** WE MAKE LIQUIDS TRANSPARENT.

SN: ISA01234

nn/nn

+24 VDC

Art.No.: 486 6000 ISA Spectrometer 

GO Systemelektronik GmbH, 24108 Kiel, Germany  
Tel.: +49(0)431/580800 Email: info@go-sys.de Internet: www.go-sys.de

### 3 Commissioning and Operation Notes



Never deliver the devices to other persons without this manual. The manufacturer is not liable for improper or unintended usage.

The instrument is constructed according to the low voltage code and to the safety regulations for electronic measuring devices.

Correct function and safety can only be ensured when both general and system-specific safety measures are followed.

Before connecting to the power supply, ensure that the voltage is suitable.

The proper functioning and operational safety of the devices can only be guaranteed under suitable ambient conditions.

If the instrument is moved from a cold to a warm environment, condensation might form which could influence its function. In this case, wait for the instrument to reach equilibrium with the new surroundings before use.

Maintenance and repair work may only be carried out by technicians authorised by GO Systemelektronik.

If it is suspected that the instrument cannot be used without danger, it must be shut down and prevented from further use.

The user's safety might be affected if the instrument shows signs of damage, does not function properly, has undergone long storage under unsuitable conditions or was subject to extreme transport conditions.

In case of doubt, please notify the manufacturer GO Systemelektronik GmbH and, if necessary, send the devices for repair or maintenance.



Older sensor heads have glass plates made of quartz glass. New sensor heads have glass plates made of sapphire glass: Sapphire glass is more resistant than quartz glass.

Year of manufacture  $\leq 2018 \Rightarrow$  Quartz glass      Year of manufacture  $\geq 2019 \Rightarrow$  Sapphire glass

Year of Revision  $\geq 2019 \Rightarrow$  Sapphire glass

In case of doubt please contact GO Systemelektronik.



**Caution:** Quartz glass plates are not suitable for contact with strong organic solvents (e.g. acetone), strong acids and strong bases.

#### 3.1 Safety Notes



**Caution:** The sensor head must not be exposed to negative pressure or pressure shocks.



**Caution:** The fibre optic cable must not be bent or flexed with a radius less than 40 mm.  
**ISA-SDU:** Do not kink the fibre optic cable.



**Caution:** The sensor head must not be hung on the sensor head cable, please use the eyebolts for installation of the sensor head.

## 4 Commissioning

After installation of the measuring system, switch-on the BlueBox power supply. During initialisation the Blue-Box automatically detects the spectrometer.

At initial commissioning of the measuring system, it is necessary to carry out a **base calibration**. The base calibration procedure is described in section 4.2.

### 4.1 Initial Cleaning of the two Glass Panes of the Measurement Path

Before calibration you have to clean the glass panes of the measurement path.

When cleaning, pay attention to any adhering particles, which should be removed with compressed air before using a brush or cloth so that the glass panes are not scratched during cleaning.

**i** Older sensor heads have glass plates made of quartz glass. New sensor heads have glass plates made of sapphire glass: sapphire glass is more resistant than quartz glass.  
 Year of manufacture  $\leq 2018 \Rightarrow$  Quartz glass      Year of manufacture  $\geq 2019 \Rightarrow$  Sapphire glass  
 Year of Revision  $\geq 2019 \Rightarrow$  Sapphire glass  
 In case of doubt please contact GO Systemelektronik.



**Caution:** Quartz glass plates are not suitable for contact with strong organic solvents (e.g. acetone), strong acids and strong bases.

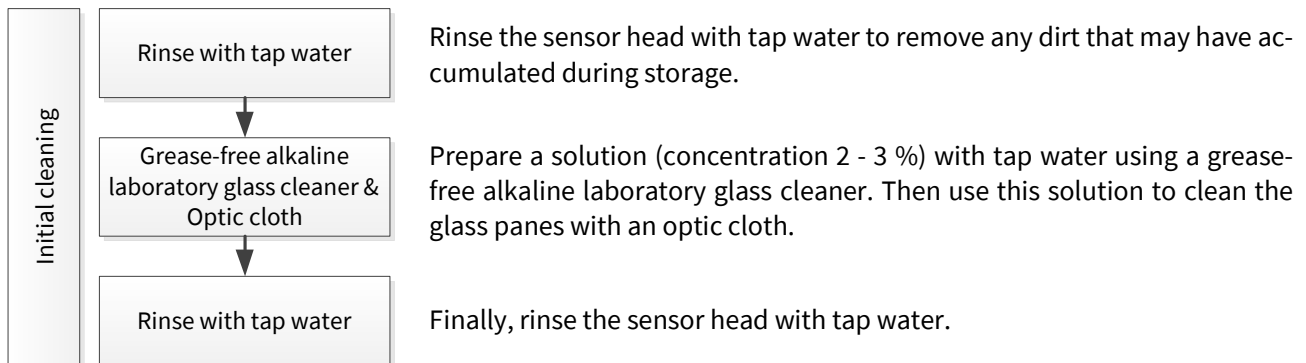

The manual cleaning of the glass panes must be repeated regularly in measurement operation, see 5. *Maintenance*

If you have the ability and the measurement takes place in heavily polluted media, the operation of the compressed air cleaning is recommended.

## 4.2 Base Calibration

- The base calibration is used to optimally utilize the measuring range of the spectrometer and to suppress the individual characteristics of the measuring system.
- The digital values (counts) of the raw spectra are influenced by four factors:
  - ⇒ the resolution of the analogue digital converter, here 0 to 32000
  - ⇒ the length of the measurement path
  - ⇒ the number of light flashes per single measurement (Intensity)
  - ⇒ the measurement medium

**i Note:** Any change in the measurement set-up requires a recalibration.

- The base calibration can be performed in various ways:
  - ⇒ on the BlueBox Display
    - BlueBox T4/TS with direct input
    - BlueBox R1/RS with direct input
    - BlueBox R1/RS as guided calibration, see 4.2.7
  - ⇒ with the PC program AMS

### 4.2.1 Work Flow of the Base Calibration

The base calibration consists of 4 steps:

1. Initial setting of the measurement path length to 10 mm; if you already have experience with your application medium, you can take them into account here.  
see 4.2.3 *Setting the Measurement Path Length*
2. Initial setting of the intensity (number of light flashes per single measurement) to 25; if you already have experience with your application medium, you can take them into account here.  
see 4.2.4 *Adjusting the Intensity (Light Intensity)*.
3. Adjustment of the intensity\*.  
see the flow chart on the next page and 4.2.5 *Intensity Calibration (Light Intensity)*
4. Adjustment of the measurement path length  
see the flow chart on the next page  
and 4.2.6 *Clearwater Calibration*  
The clearwater calibration is also called zero calibration.

The basic calibration is followed by the application-specific calibration, see 4.3 *Application-Specific Calibration*.

\* The adjustment of the intensity is the mutual adaption of the light intensity (= number of flashes per measurement) and the measurement path length. The adjustment of the light intensity is also called here, not entirely correct, as intensity calibration. In fact, the adjustment of the intensity is the actual intensity calibration.

4.2.2 Flow Chart of the Base Calibration

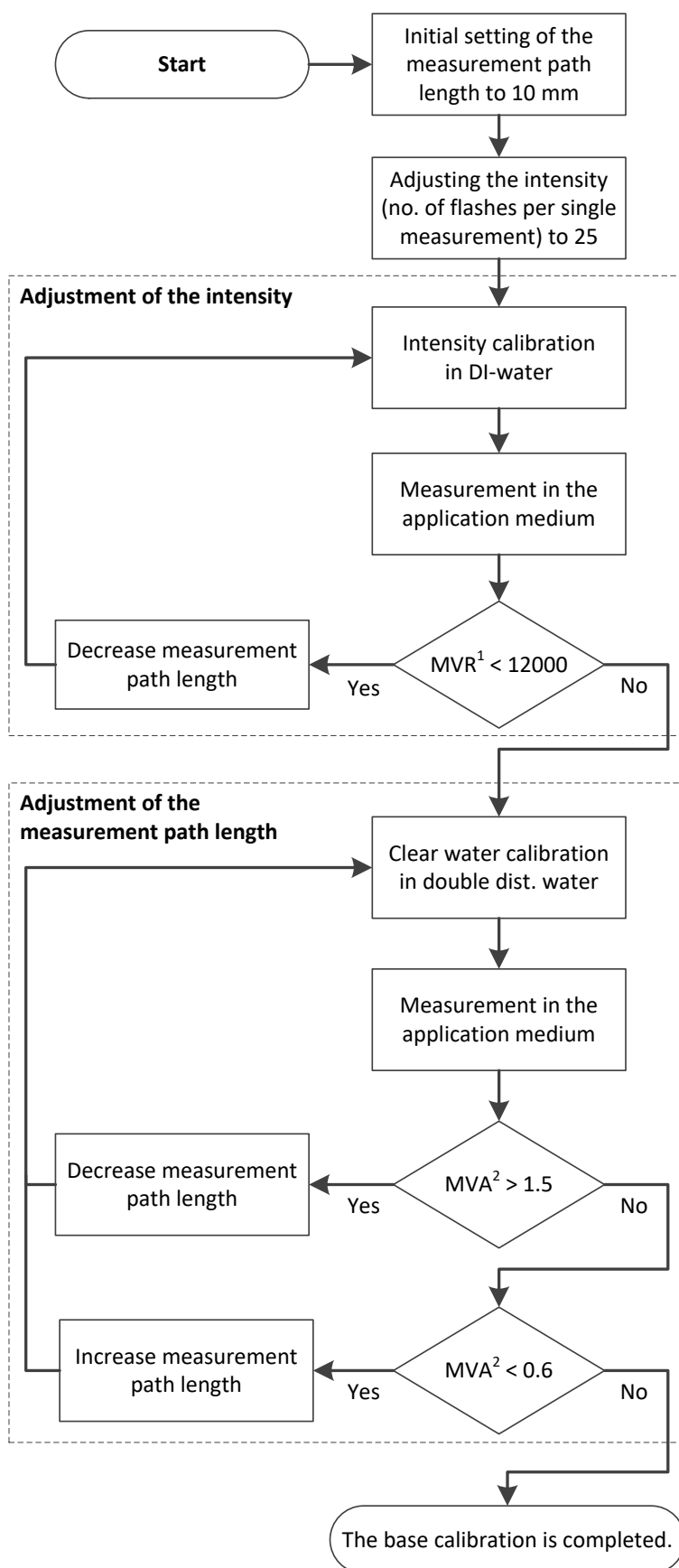

<sup>1</sup> MVR = Maximum digital Value of a Raw spectrum

<sup>2</sup> MVA = Maximum Value of an Absorbance spectrum

**i** From an MVA of 1.3 increasing, the non-linear range begins, above 1.7 the signal is noisy.

## 4.2.3 Setting the Measurement Path Length

Set the measurement path length with the setscrew on the underside of the sensor head.  
Measure the measurement path length with a vernier calliper. Pay attention to the optics.

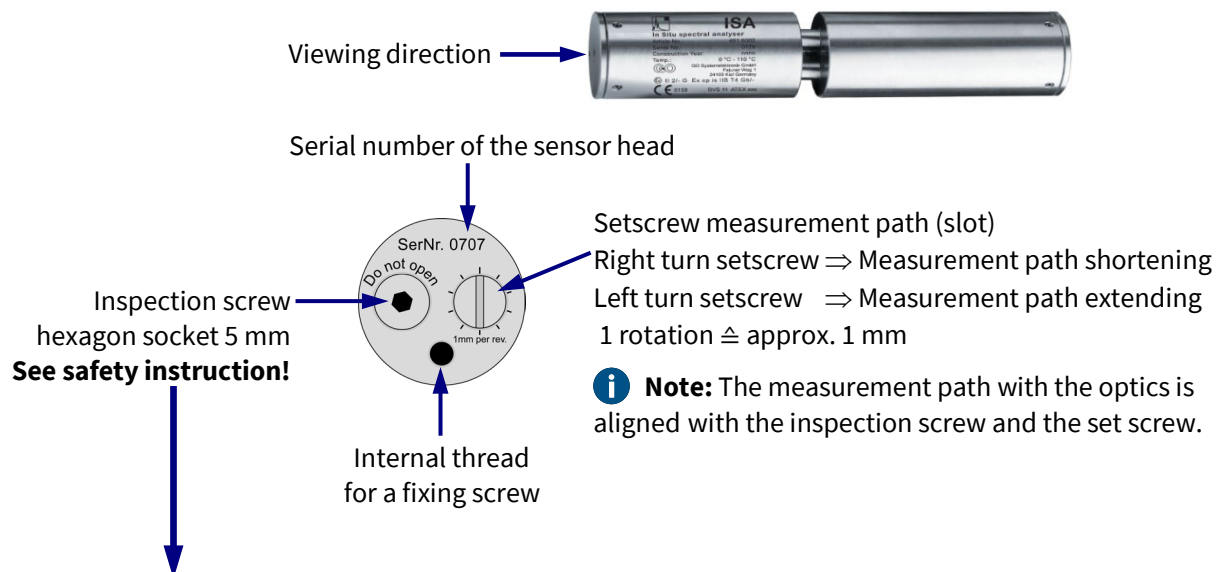



**Caution:** Never loosen the inspection screw!  
After loosening or unscrewing the inspection screw the proper function cannot be ensured.

**Loss of warranty!**  
After loosening the inspection screw the sensor head must go to the manufacturer for inspection.

You can simplify the setting of the measurement path length by using spacers.

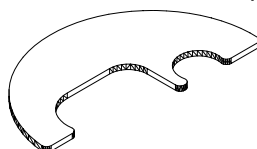

Available in heights | 0.5 mm | 1 mm | 5 mm | 10 mm | 20 mm |  
Article number 330 9399-X

A long measurement path (15 – 20 mm) is used in clean water (drinking water monitoring, groundwater monitoring, river monitoring). A short measurement path (1 – 3 mm) is used in waste water or process monitoring (wines, syrups, oils).

Generally spoken, the more polluted or light-absorbing the medium, the smaller the measurement path.

**Note:** see also 1.1 Specifics Sensor Head ISA-SDU

## 4.2.4 Setting the Intensity (Light Intensity)

The xenon lamp flashes with constant intensity and constant frequency. The intensity calibration determines the integration time, i.e. the number of light flashes per single measurement.

The setting of the intensity is possible both on the **display** of the BlueBox and with the **AMS program** as part of the BlueBox PC Software.

The number of flashes per single measurement depends on the application and is in practice between 3 and 50.

### 4.2.4.1 Setting the Intensity at the BlueBox Display

#### BlueBox TS and BlueBox T4

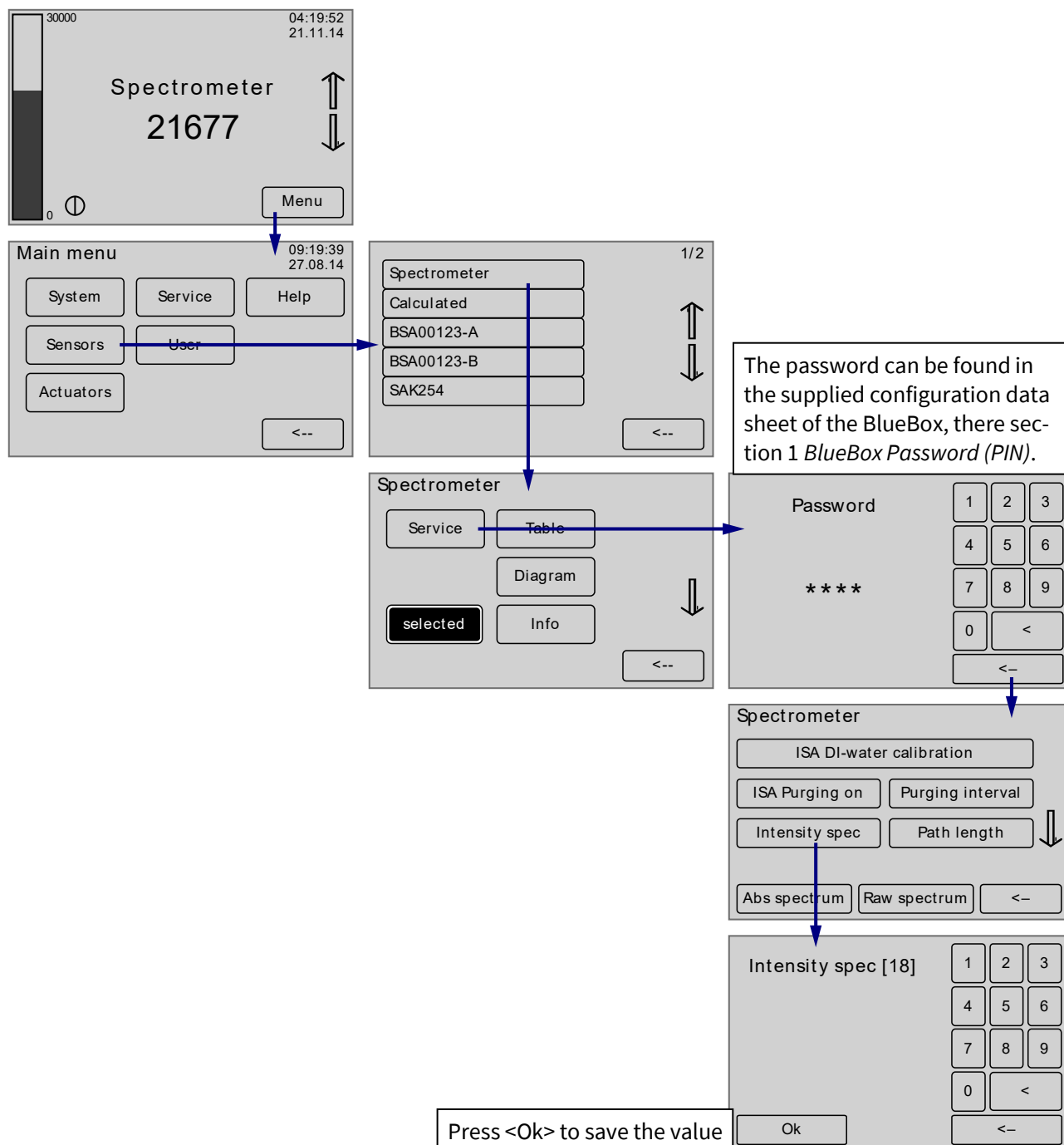

# ISA - Commissioning

## BlueBox R1 and BlueBox RS

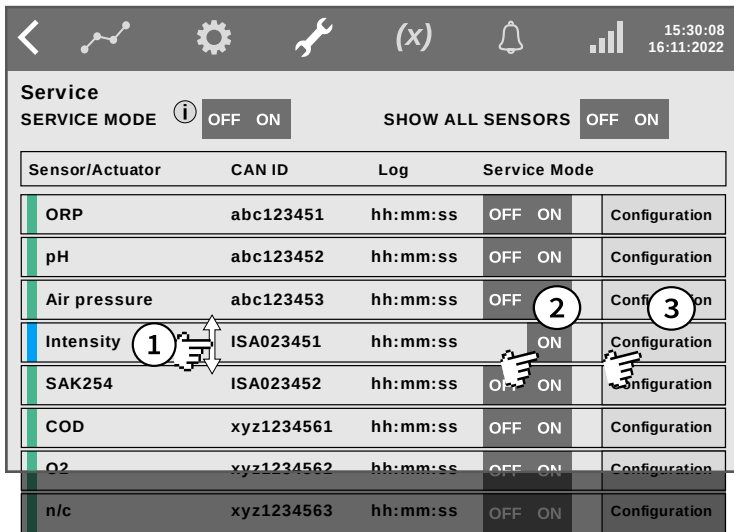

Open the Service Display.

The password can be found in the enclosed Configuration Data Sheet of the BlueBox, there section 1 *BlueBox Password (PIN)*.

- ① If necessary, swipe vertical to the Intensity line.
- ② Activate the Service Mode.
- ③ Tap on **Configuration** to open the Spectrometer Configuration Selection Display.

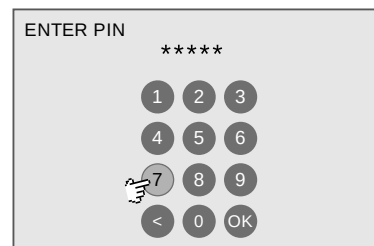
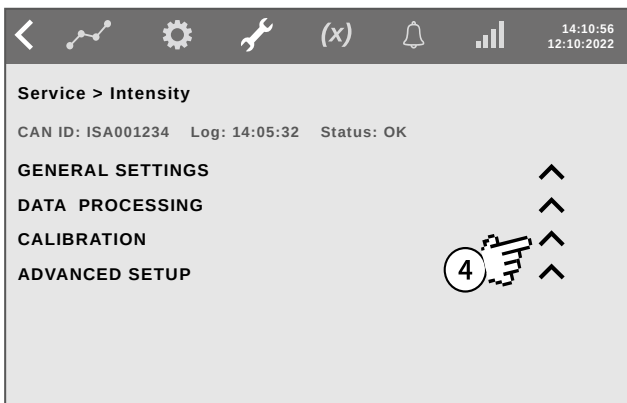

The password can be found in the supplied configuration data sheet of the BlueBox, there section 1 *BlueBox Password (PIN)*.

- ④ Tap on CALIBRATION ^

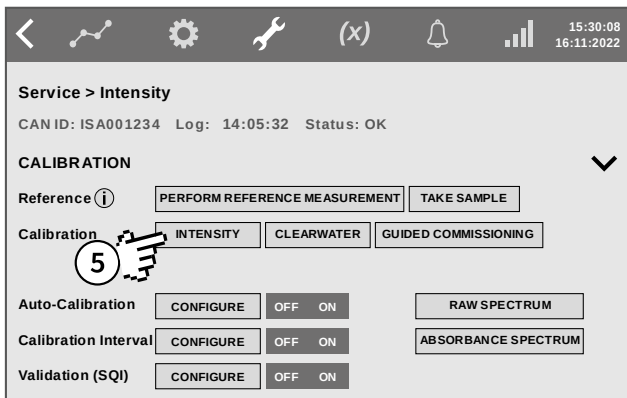

- ⑤ Tap on **INTENSITY**

### Intensity input display

- Tap numeric keys.
- Deletes the character left of the cursor. ←
- Saves the entry. ←

△ < > No function here

- ⑥ Enter the intensity value and save the entry.

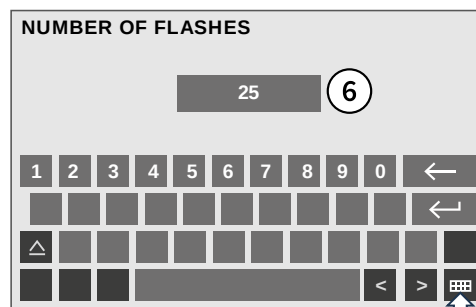

- Keyboard-symbol Returns to the previous display without saving an entry.



### 4.2.4.2 Setting the Intensity with the program AMS

Start the program AMS, e.g. via the program BlueBoxSoft like here:

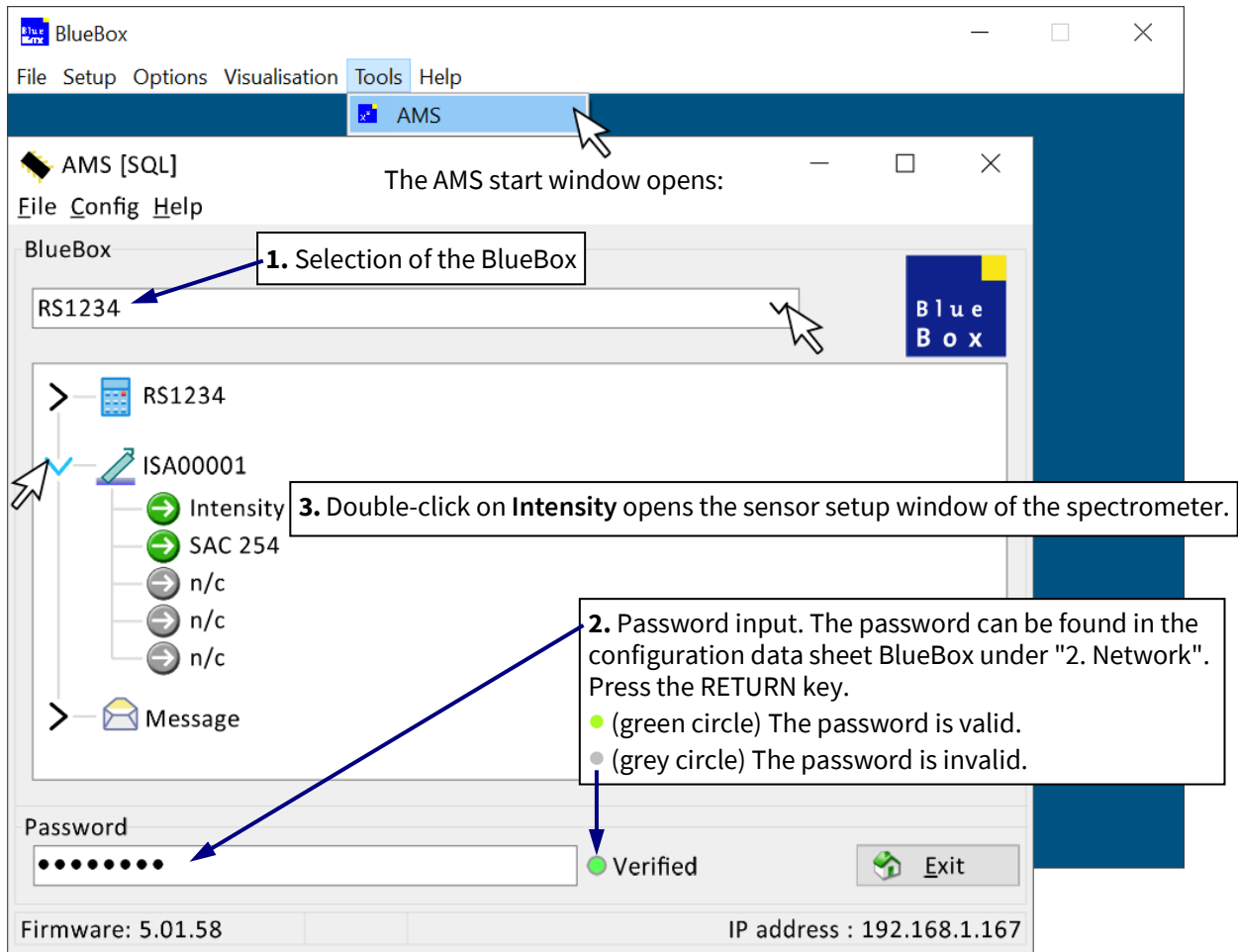

**Example:** Configuration with only one connected spectrometer and the application-specific parameter SAC254 (set up by default).

**Sensor setup window:**

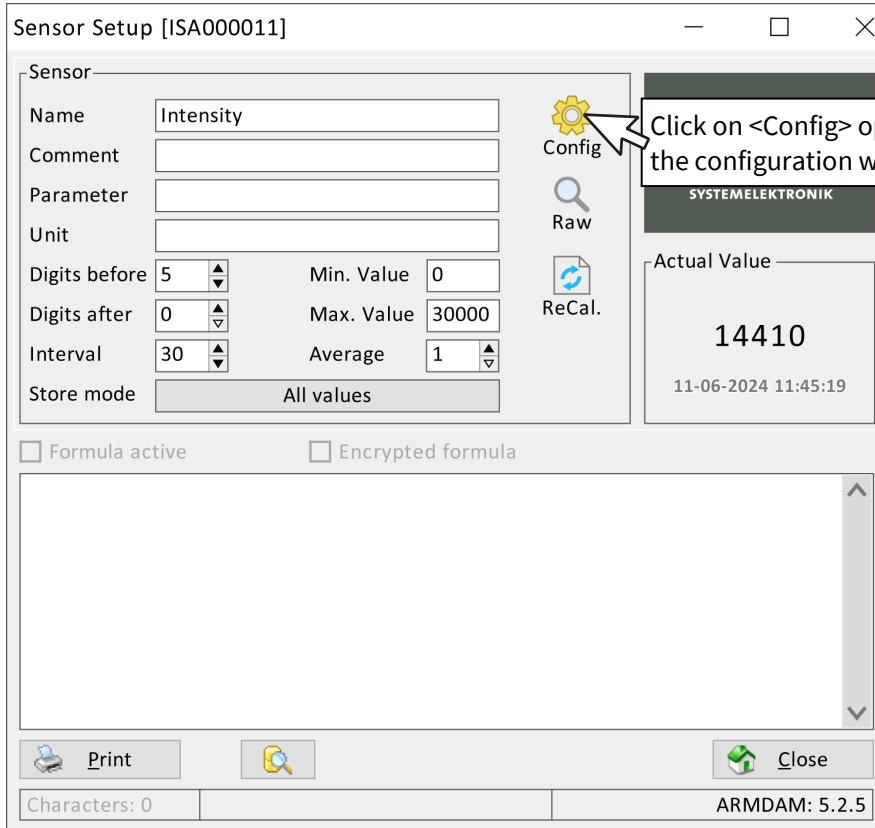

**Sensor configuration window:**

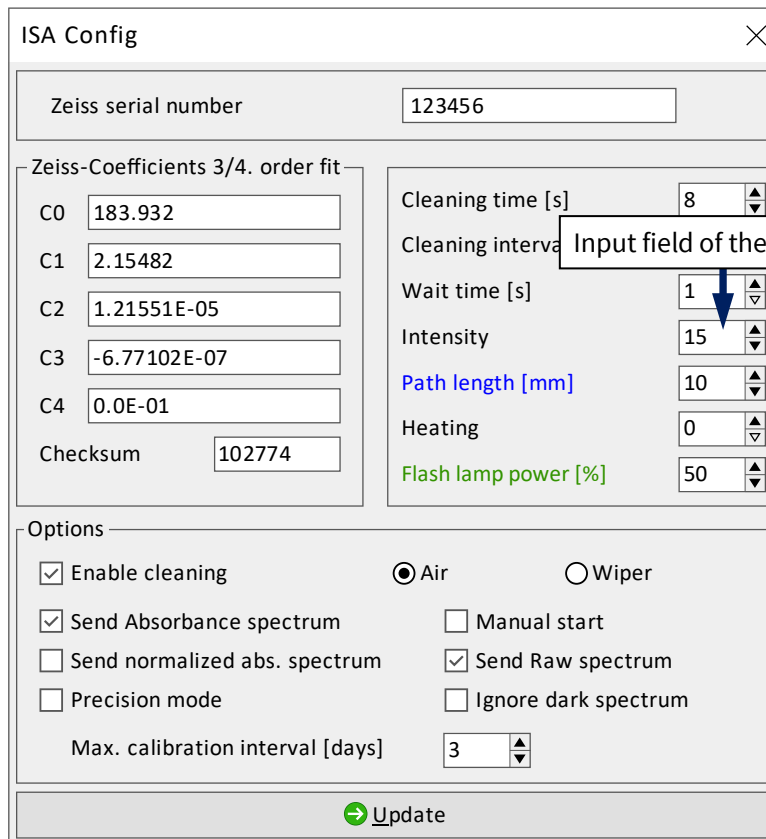

Click on <Update> transmits the settings via the BlueBox to the spectrometer module.

### 4.2.5 Intensity Calibration (Light Intensity) with the program AMS

**Note:** The intensity calibration is also called DI-water calibration.

**Reference:** The intensity calibration in DI-water is part of the adjustment of the intensity. The purpose of the adjustment of the intensity is to utilise the measuring range in the application medium so that the digital values of the absorbance are within the linear range. The value of the absorbance depends on the intensity (light intensity), i.e. the number of light flashes per individual measurement.

The intensity calibration in DI-water sets the number of light flashes per single measurement so that the MVR\* of the calibrated raw spectrum is below 29200.

**Precondition:**

**Rinse the sensor head in DI-water and immerse the sensor head in DI-water immediately afterwards.**

Start the program AMS, e.g. via the program BlueBoxSoft like here:

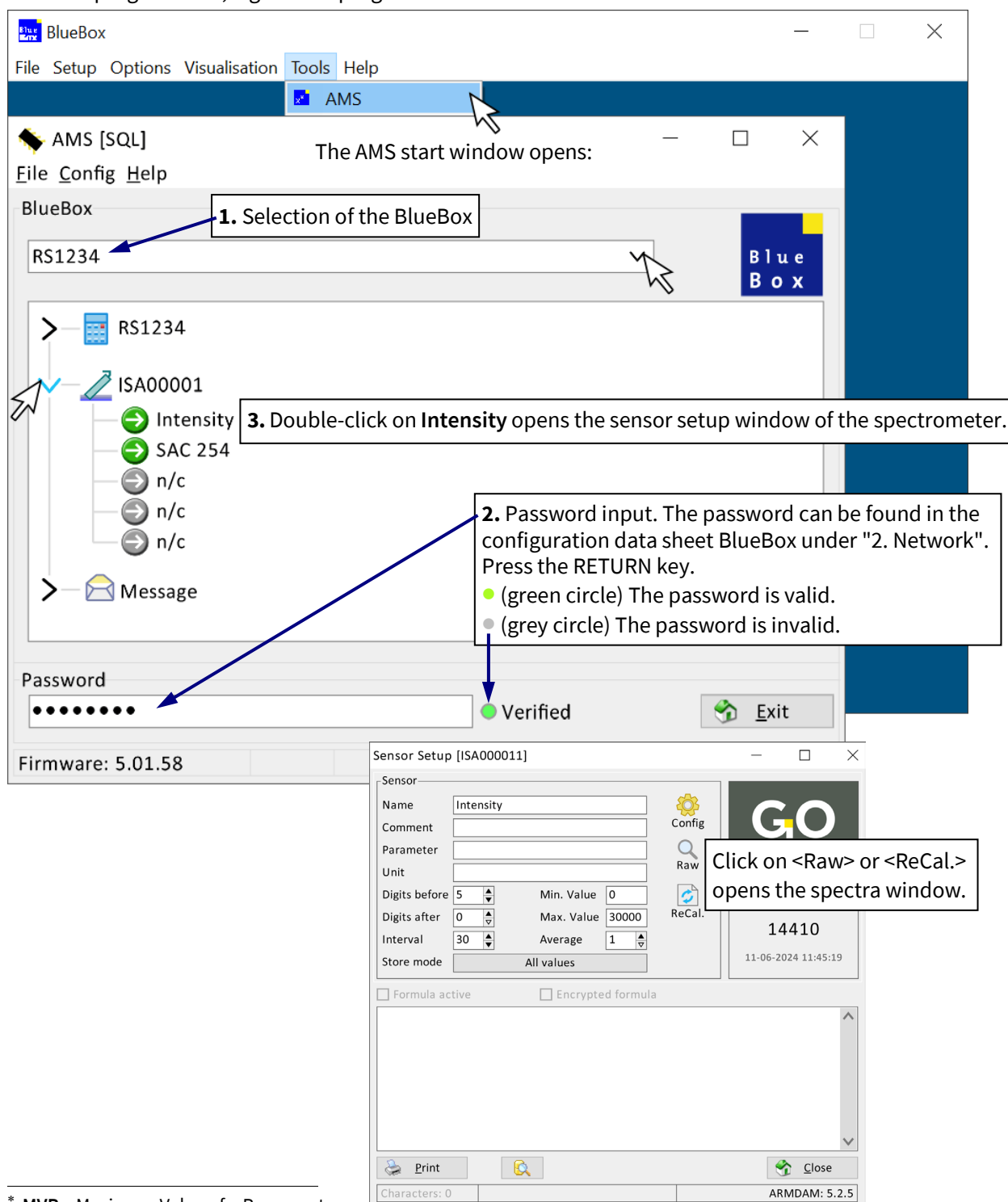

The screenshot shows the BlueBox software interface. The main window is titled 'BlueBox' and has a menu bar with 'File', 'Setup', 'Options', 'Visualisation', 'Tools', and 'Help'. The 'Tools' menu is open, showing 'AMS' as the selected option. A secondary window titled 'AMS [SQL]' is open, displaying 'The AMS start window opens:'. This window has a menu bar with 'File', 'Config', and 'Help'. The main area shows a tree view with 'BlueBox' at the top, followed by 'RS1234'. Under 'RS1234', there is a sub-tree for 'ISA00001' containing 'Intensity', 'SAC 254', and three 'n/c' items. A 'Message' icon is at the bottom. A 'Password' field is visible with a green 'Verified' indicator and an 'Exit' button. The 'Firmware: 5.01.58' is shown at the bottom left. A 'Sensor Setup [ISA000011]' window is overlaid on top, showing fields for Name (Intensity), Comment, Parameter, Unit, Digits before (5), Digits after (0), Interval (30), Store mode (All values), Min. Value (0), Max. Value (30000), and Average (1). It also has 'Config', 'Raw', and 'ReCal.' buttons. A 'GO' logo is in the top right of this window. A '14410' value and a timestamp '11-06-2024 11:45:19' are displayed. At the bottom, there are 'Print' and 'Close' buttons, and 'Character: 0' and 'ARMDAM: 5.2.5' are shown.

**1. Selection of the BlueBox**

**2. Password input.** The password can be found in the configuration data sheet BlueBox under "2. Network". Press the RETURN key.  
 ● (green circle) The password is valid.  
 ● (grey circle) The password is invalid.

**3. Double-click on Intensity** opens the sensor setup window of the spectrometer.

Click on <Raw> or <ReCal.> opens the spectra window.

\* MVR = Maximum Value of a Raw spectra

The digital measurement values of the spectrum are shown in the spectra window as a line graph. Here is an example of an overdriven spectrum, i.e. the intensity is too high.

The intensity calibration in DI-water sets the number of light flashes per single measurement so that the MVR\* of the calibrated raw spectrum is below 29200.

## View spectra window:

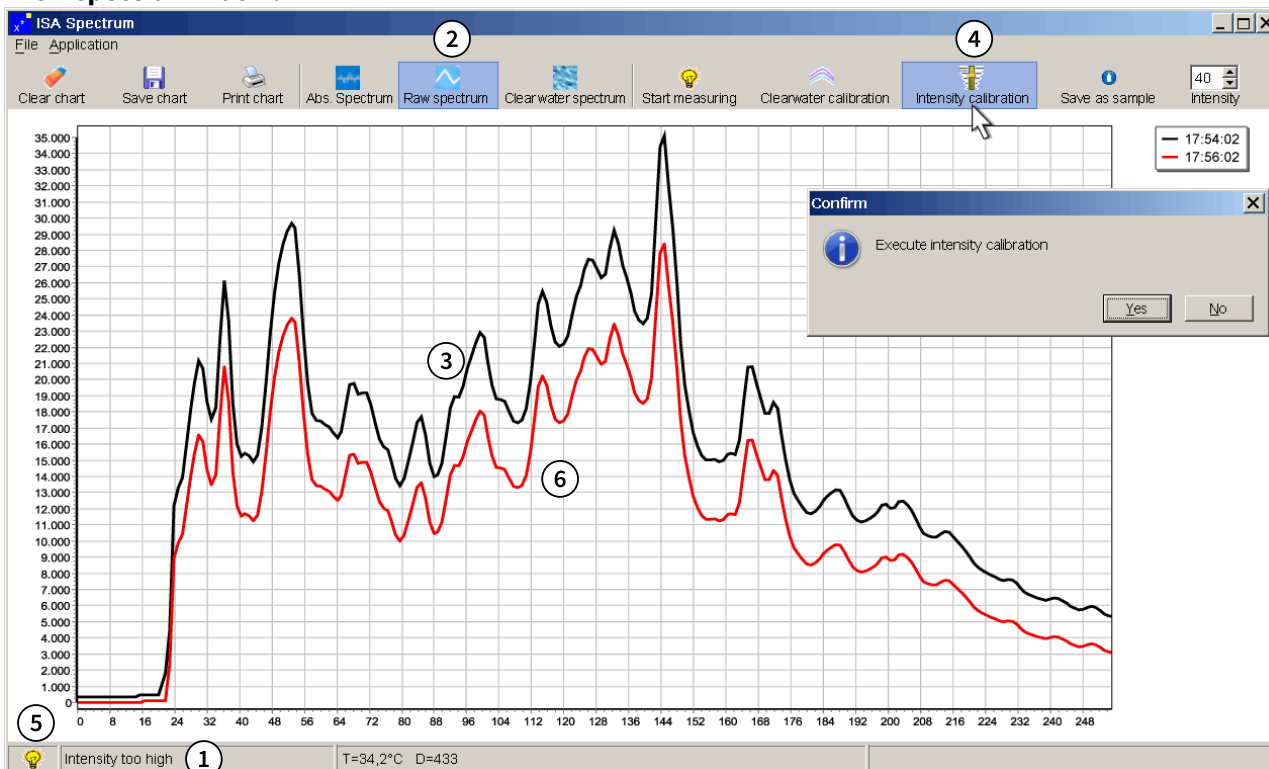

### Precondition:

Rinse the sensor head in DI-water and immerse the sensor head in DI-water immediately afterwards.

- ① If spectra are overdriven, it is displayed in this text field.
- ② Switch to the view of the raw spectra.
- ③ The current raw spectrum is displayed after the next measurement, or after click on button <Start measuring>.
- ④ Click button <Intensity calibration> and then in the confirmation window on <Yes>>.
- ⑤ With the next measurement, the calibration starts. During the calibration the light bulb symbol flashes in the lower left followed by the hourglass icon for the transmission of the spectra data to the BlueBox. The intensity, i.e. the number of light flashes per single measurement, is set automatically.
- ⑥ After the end of the intensity calibration, the calibrated spectrum is displayed. The intensity calibration is completed.

Thereafter a new raw spectrum is displayed with every measurement, but not more than the last 20.

\* MVR = Maximum Value of a Raw spectra

### 4.2.6 Clear Water Calibration

**Reference:** The clear water calibration<sup>1</sup> of the spectrometer is carried out in **double distilled water**. With the clear water calibration, the individual properties of the measuring system are detected as a reference. The following measurement values are adjusted accordingly.

This clear water calibration should be repeated at regular intervals (every 1 to 3 months, depending on the application). This clear water calibration is possible both at the BlueBox display and with the program AMS as part of the BlueBox PC Software.

#### 4.2.6.1 Clear Water Calibration at the BlueBox Display

**Precondition:** Rinse the sensor head in double distilled water and immerse the sensor head in double distilled water immediately afterwards.

- The MVR<sup>2</sup> should be in the range of 26.000 to 29.500 counts.
- If the MVR<sup>2</sup> is not in this range, adjust the measurement path length or repeat the adjustment of the intensity.

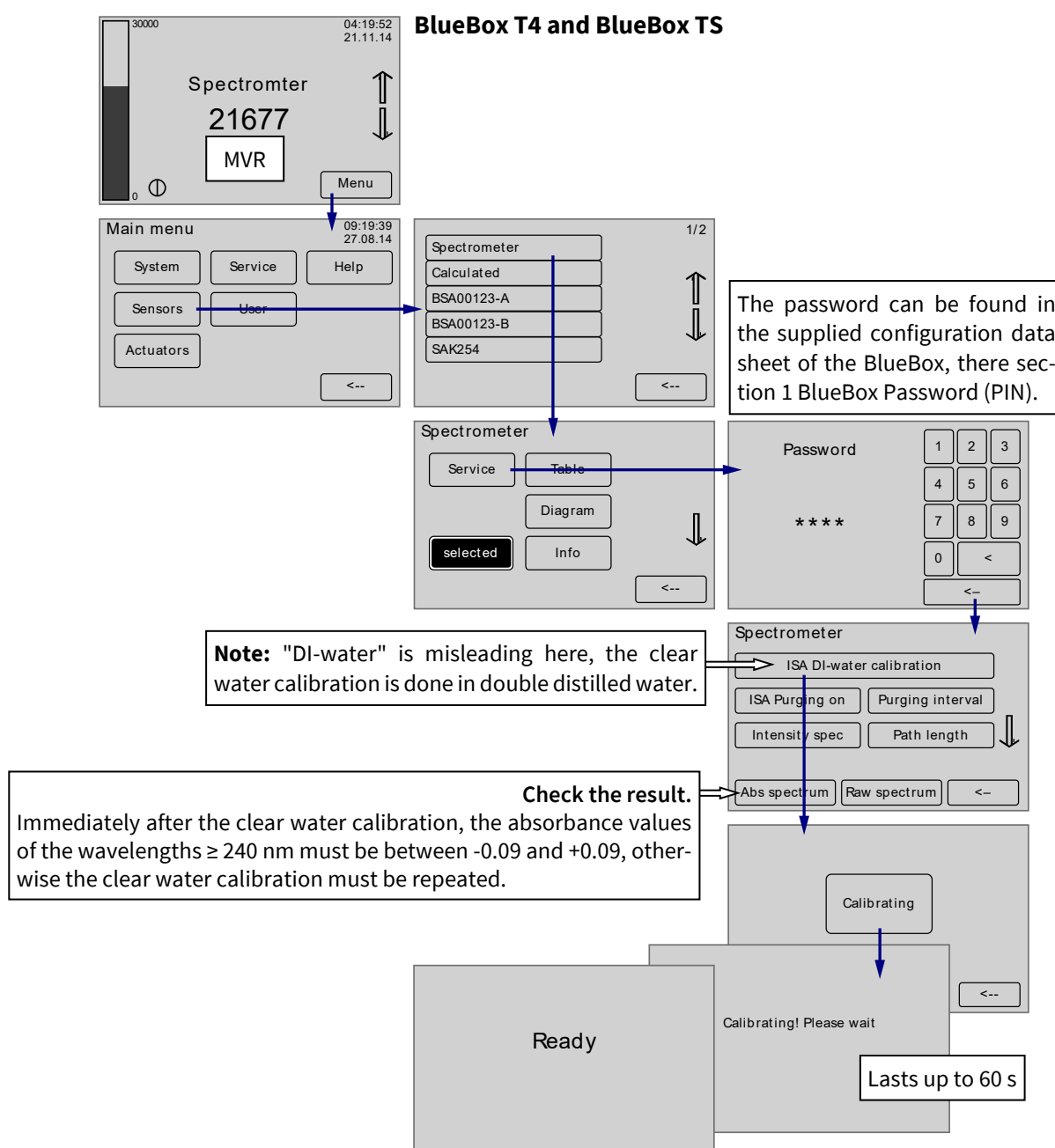



<sup>1</sup> also called zero calibration

<sup>2</sup> MVR = Maximum digital Value of a Raw spectrum

# ISA - Commissioning

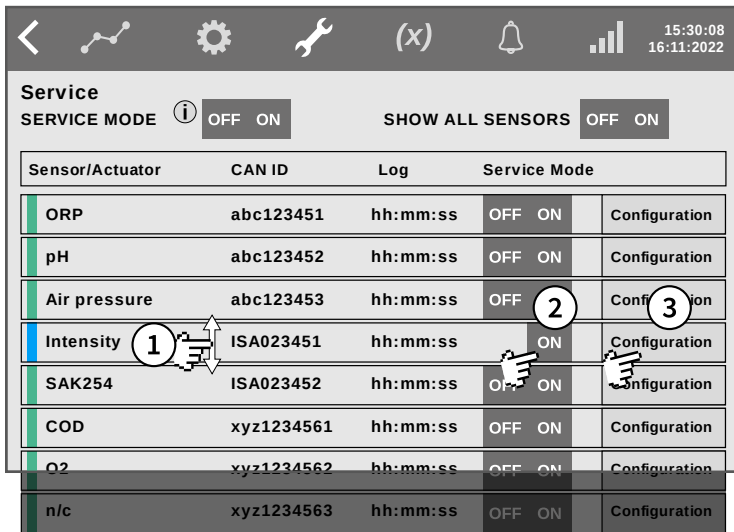
## BlueBox R1 and BlueBox RS



 Open the Service Display.

- ① If necessary, swipe vertical to the Intensity line.
- ② Activate the Service Mode.
- ③ Tap on **Configuration** to open the Spectrometer Configuration Selection Display.

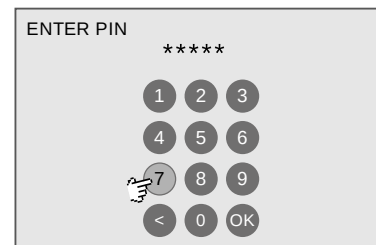
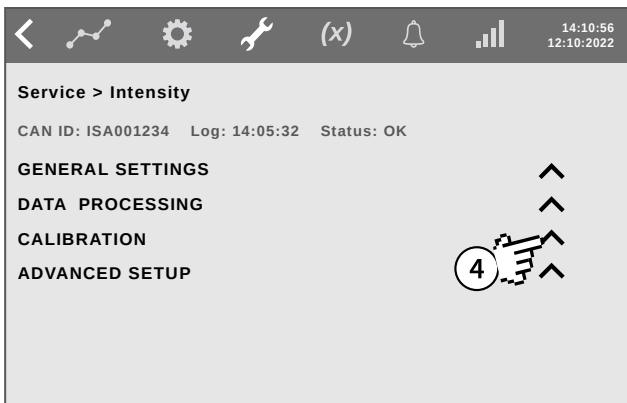

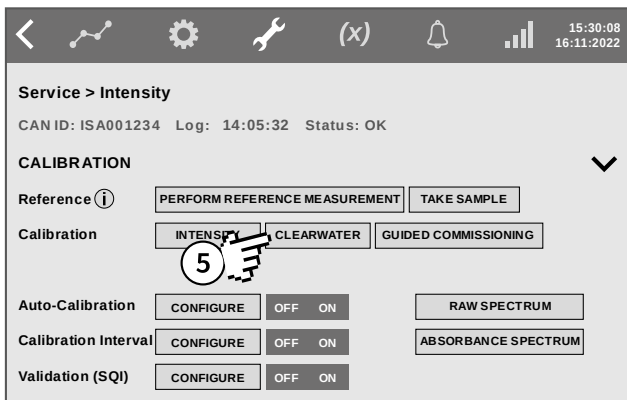

The password can be found in the enclosed Configuration Data Sheet of the BlueBox, there section 1 *BlueBox Password (PIN)*.

- ④ Tap on **CALIBRATION** 



- ⑤ Tap on **CLEARWATER**

### Calibration check

- If there is a , the calibration is completed successful. If there is a , the calibration was not successful. The MVR\* should be in the range of 26.000 to 29.500 counts. Tap on **SHOW CLEARWATER SPECTRUM** to display the raw spectrum.
- If the MVR\* is not in this range, adjust the measurement path length or repeat the adjustment of the intensity.

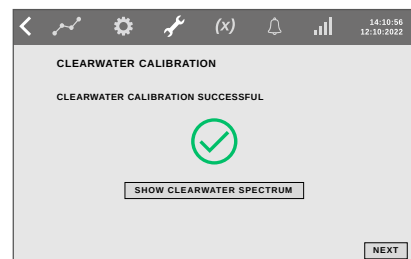

If the Clear Water Calibration is successful, tap **NEXT**

\* MVR = Maximum digital Value of a Raw spectrum

### 4.2.6.2 Clear Water Calibration with the program AMS

Start the program AMS, e.g. via the program BlueBoxSoft like here:

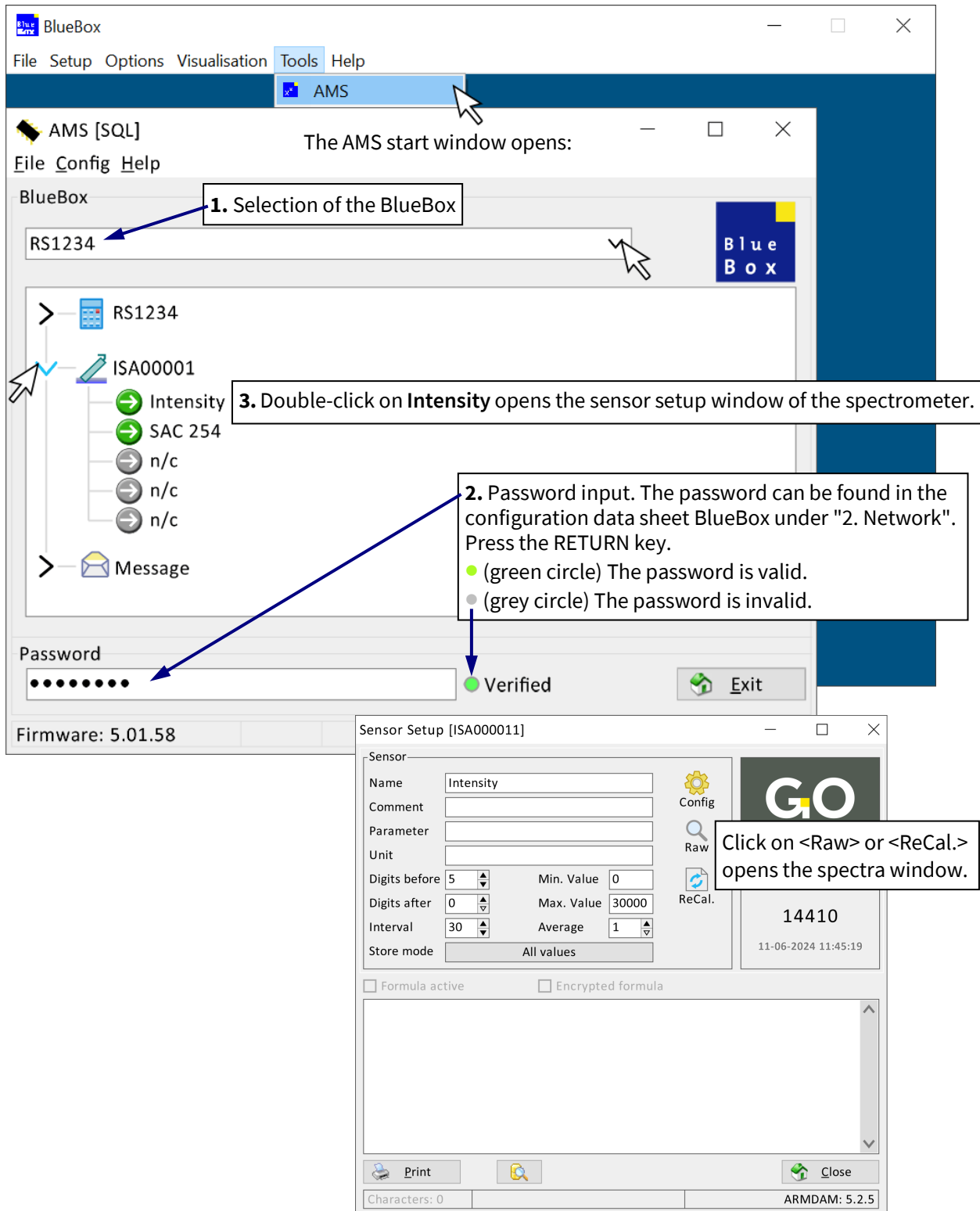

The AMS start window opens:

- Selection of the BlueBox
- Password input. The password can be found in the configuration data sheet BlueBox under "2. Network". Press the RETURN key.
  - (green circle) The password is valid.
  - (grey circle) The password is invalid.
- Double-click on Intensity opens the sensor setup window of the spectrometer.

Click on <Raw> or <ReCal.> opens the spectra window.

Sensor Setup [ISA000011]

Name	Intensity
Comment	
Parameter	
Unit	
Digits before	5
Digits after	0
Interval	30
Min. Value	0
Max. Value	30000
Average	1
Store mode	All values

14410  
11-06-2024 11:45:19

Formula active  Encrypted formula

Print Close

Characters: 0 ARMDAM: 5.2.5

The digital measurement values of the spectrum are shown in the spectra window as a line graph. If no spectrum is shown, wait until the next measurement.

## View spectra window:

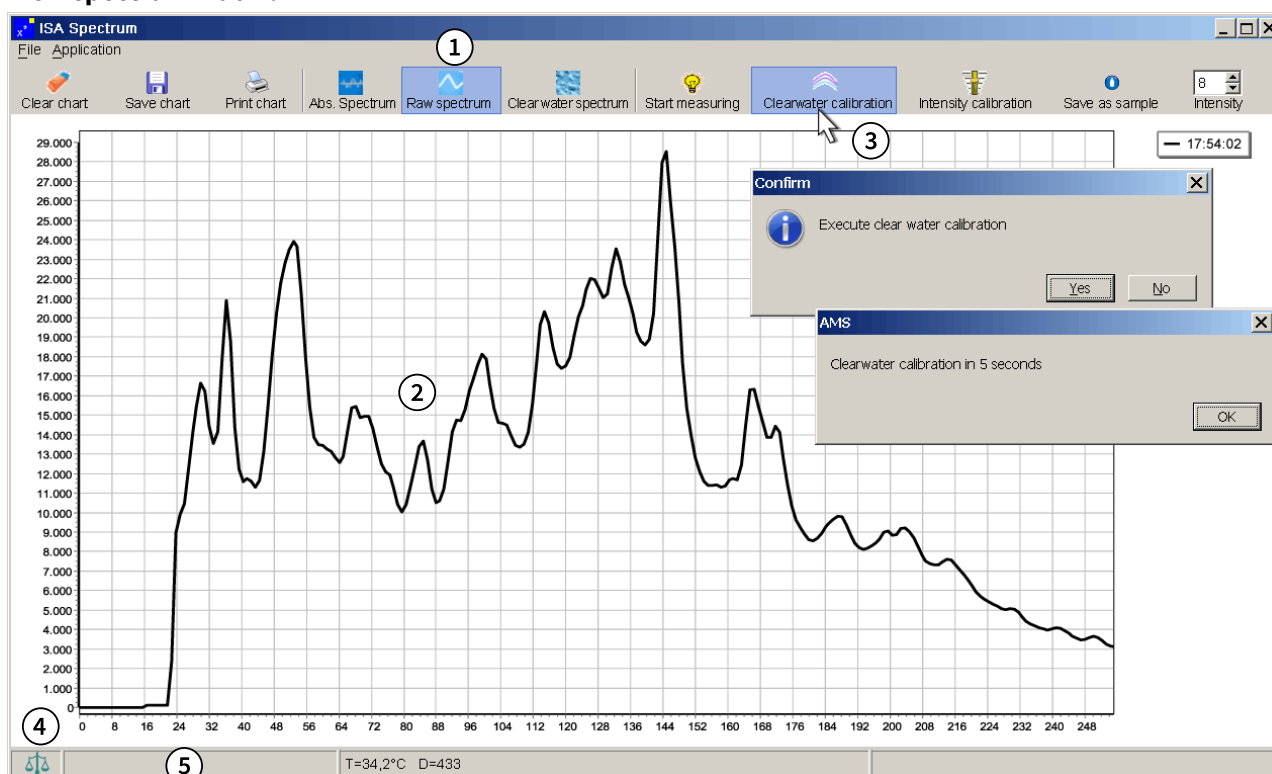

**Precondition: Rinse the sensor head in double distilled water and immerse the sensor head in double distilled water immediately afterwards.**

- ① Switch to the view of the raw spectra.
- ② The current raw spectrum is displayed after the next measurement, or after click on button <Start measuring>.
  - The MVR\* should be in the range of 26.000 to 29.500 counts.
  - If the MVR\* is not in this range, adjust the measurement path length or repeat the adjustment of the intensity.
- ③ Click button <Clearwater calibration> and then in the confirmation window on <Yes>, then in the following window on <OK>.
- ④ During the calibration process, the scale symbol appears at the bottom left. The calibration calculation is completed as soon as the scale symbol disappears.
- ⑤ Message field of the status messages  
Messages concerning the clear water calibration:
  - **Intensity to high** –The combined MVR\* of the raw spectrum and the dark spectrum is greater than 32000
  - **Please make a clear water calibration** – The clear water calibration interval is exceeded.  
⇒ Perform a clear water calibration.

**To check the clear water calibration switch to the view of the absorbance spectra. see next page**

\* MVR = Maximum Value of a Raw spectra



View spectrum window absorbance spectra:

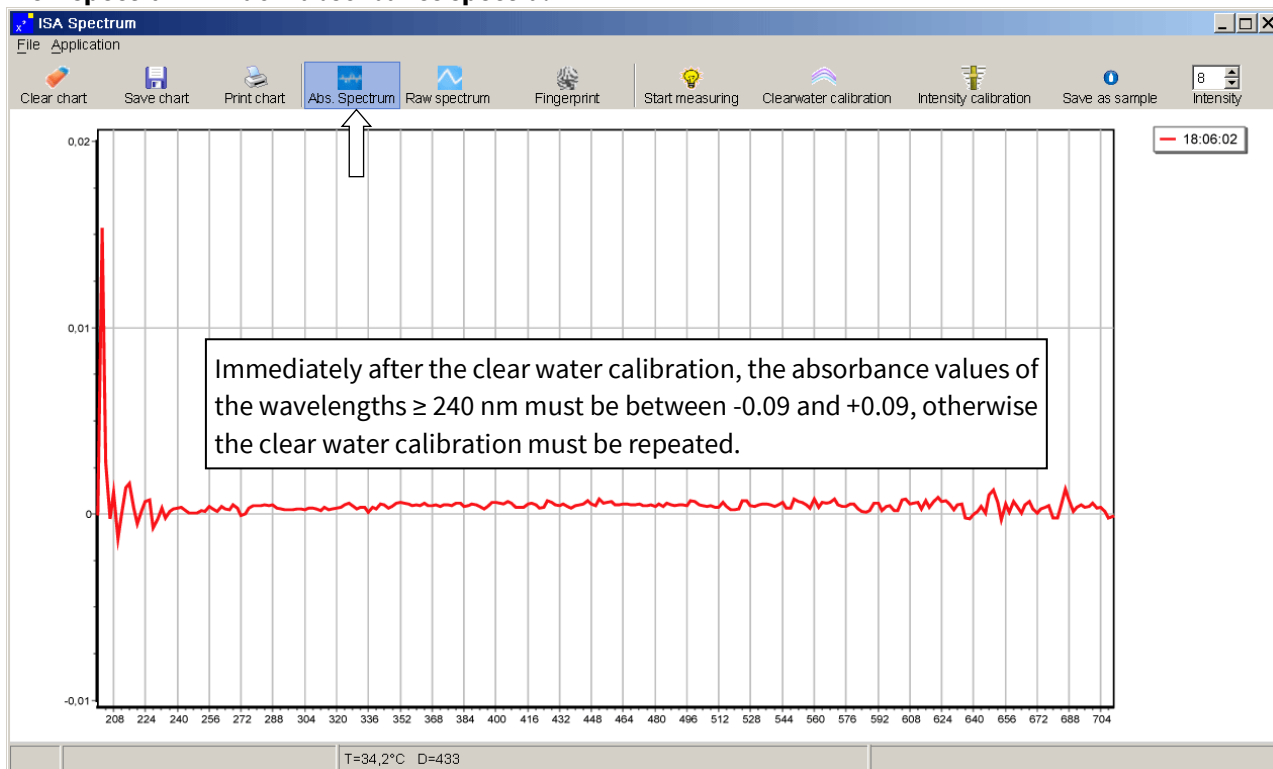

The clear water calibration is completed. You can quit the program.

**Note:** The raw spectrum with which calibration was performed is saved as a clear water spectrum and is displayed by clicking on the <Clear water spectrum> button.

4.2.6.3 Messages of the Clear Water Calibration at BlueBox T4 and BlueBox TS

If a maximum raw value (MVR<sup>1</sup>) exceeds or falls below certain values after the clear water calibration, messages appear on the display.



Switches to the parameter display.

**Warning! Intensity to high!**

The MVR<sup>1</sup> is higher than 29500 counts.  
Spectral resolution range: 2 – 160 Pixel  
▶ Reduce light intensity<sup>2</sup>

**Warning! Intensity to low!**

The MVR<sup>1</sup> is less than 24000 counts.  
Spectral resolution range: 2 – 160 Pixel  
▶ Increase light intensity<sup>2</sup>

**Attention! Please clean spectrometer!**

The MVR<sup>1</sup> is less than 500 counts.  
Spectral resolution range: 16 – 30 Pixel  
▶ Clean spectrometer<sup>3</sup>

<sup>1</sup> MVR = Maximum digital Value of a Raw spectrum

<sup>2</sup> Light intensity = Number of light flashes per single measurement, see 4.2.4 Setting the Intensity (Light Intensity)

<sup>3</sup> see 5.3 Cleaning the Sensor Head (ISA) or 7.2 Maintenance (Process Spectrometer)

## 4.2.7 Guided Commissioning at the BlueBox R1 and BlueBox RS Display

The Guided Commissioning is a base calibration procedure that corresponds to 4.2 *Base Calibration*. Here you are guided through the sequence of calibration steps and receive feedback on the success. If necessary, you will be asked to repeat steps.

### Call-up:

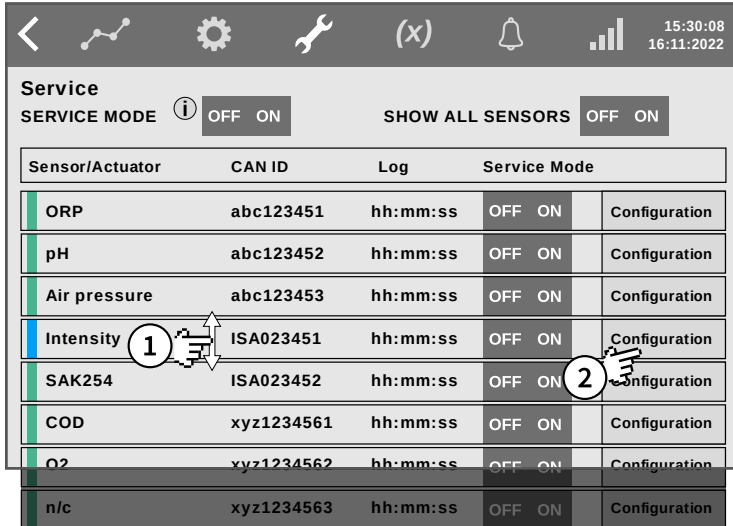

 Open the Service Display.

① If necessary, swipe vertical to the Intensity line.

② Tap on **Configuration** to open the Spectrometer Configuration Selection Display.

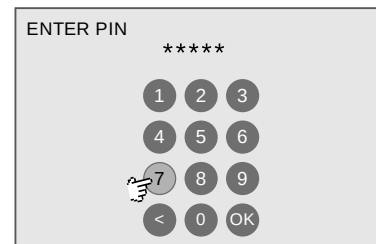
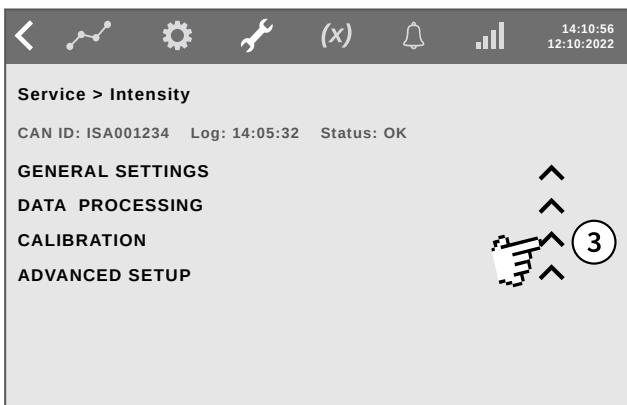

The PIN can be found in the enclosed Configuration Data Sheet of the BlueBox, there section 1 *BlueBox Password (PIN)*.

③ Tap on CALIBRATION 

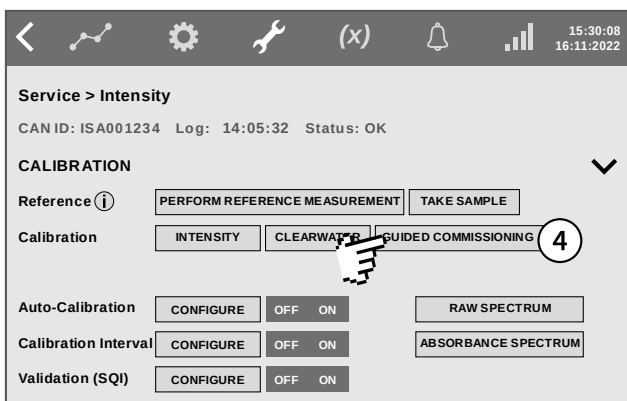

④ Tap on **GUIDED COMMISSIONING**

### 4.2.7.1 Guided Base Calibration Procedure

see also 4.2 Base Calibration

#### Procedure Start



#### STEP 1 CHECKLIST

List of things needed

#### STEP 2 ACTIVATE SERVICE MODE

Notes on the Service Mode

#### STEP 3 CONTAMINATION CHECK

Checking whether the initial cleaning (see 4.1) was successful.

#### STEP 4 VALIDATION

#### STEP 5 SET MEASUREMENT GAP

Manual initial setting of the measurement path (see 4.2.3)

#### STEP 6 INTENSITY CALIBRATION Start

**Reference:** The intensity calibration in DI-water is part of the adjustment of the intensity. The purpose of the adjustment of the intensity is to utilise the measuring range in the application medium so that the digital values of the absorbance are within the linear range. The value of the absorbance depends on the intensity (light intensity), i.e. the number of light flashes per individual measurement.

#### STEP 7 INTENSITY CALIBRATION End

#### STEP 8 CLEARWATER CALIBRATION

**Reference:** The clear water calibration\* of the spectrometer is carried out in double distilled water. With the clear water calibration, the individual properties of the measuring system are detected as a reference. The following measurement values are adjusted accordingly.

#### STEP 9 CHECK OF MEASUREMENT GAP

Iterative adaption of the measurement gap

#### STEP 10 ADAPT MEASUREMENT GAP

#### Procedure End

---

\* also called zero calibration

### 4.3 Application-Specific Calibration

For the calculation and calibration to the desired parameters of a specific application, it is necessary that for each parameter reference values from chemical laboratory analysis and the corresponding spectral values are provided.

In case of a **one-parameter calibration** a spectrum is assigned to one reference value, in a **multi-parameter calibration** there is more than one reference value assigned.

The spectral data of a spectrum plus one or more corresponding measurement values are called **reference value pair**.

The **number of required pairs of reference values pairs is 25**, a smaller number reduces the quality of calibration and consequently leads to erroneous determination of values of the parameters.

Out of the reference value pairs the software **ISA plus** and the software **ISA plus manager** compute the **calibration data** and stores **calibration files** in the xml format (with SQL) or in the txt-format (without SQL) for every single parameter.

**If you do not have the ISA plus/ISA plus manager software, please contact  
GO Systemelektronik to calculate the calibration data and the SQL.**

**SQL (Spectral Quality Index)** The SQL is a degree of the statistical reliability of measurement values and is calculated continuously for each parameter. Precondition is the creation of a corresponding calibration file in the xml format.

Afterwards, this calibration data must be transferred from a connected PC via the BlueBox to the spectrometer sensor unit using the AMS software.\*

**i Note:** The attainable accuracy can be influenced by external factors (e.g. characteristics of the medium). A warranty on the quality of the spectroscopic analysis can therefore not be given.

\* Only perform this operation by trained personal.

4.3.1 Overview Application-Specific Calibration

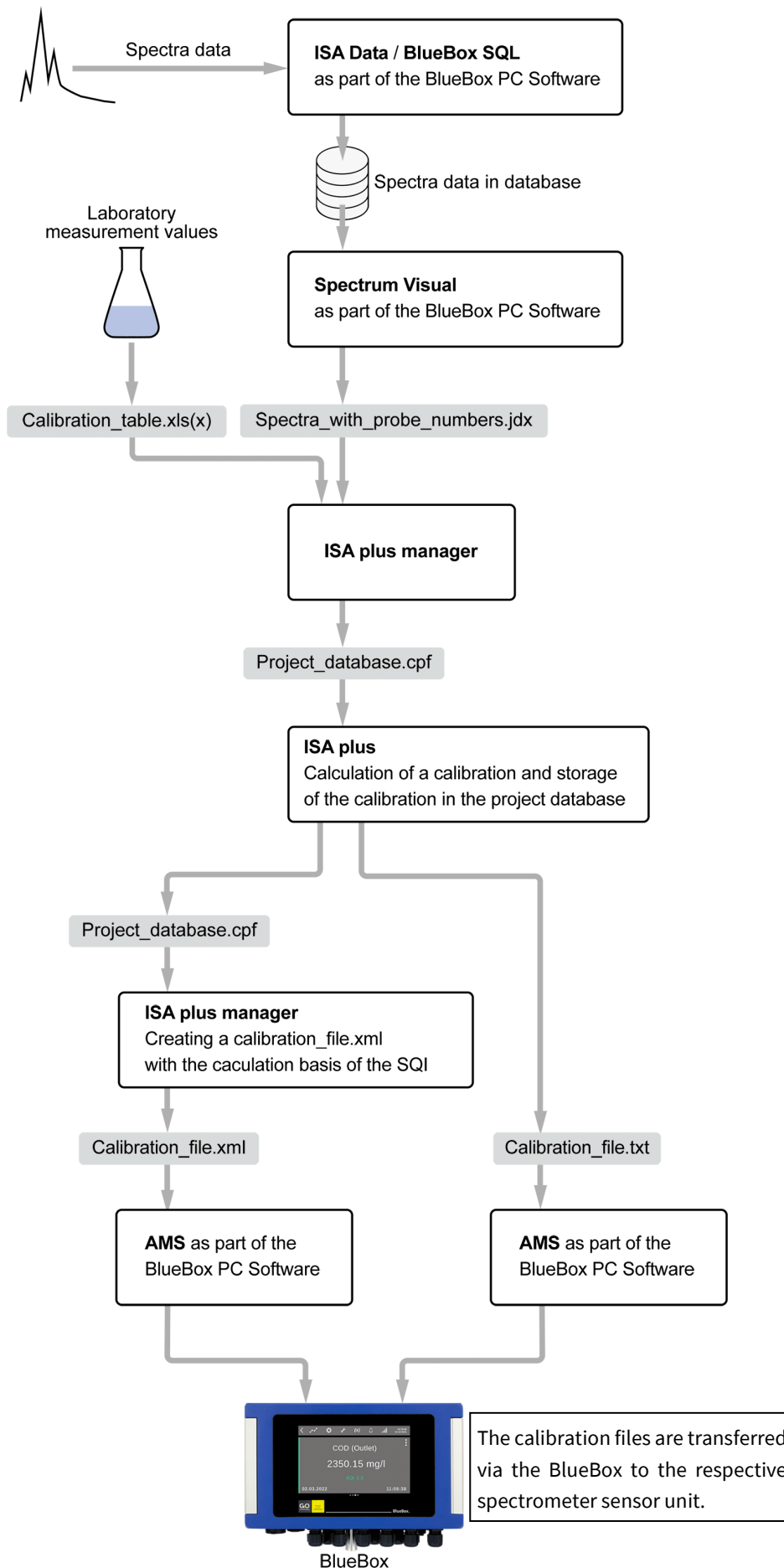

### 4.3.2 Flow Chart of the Application-Specific Calibration

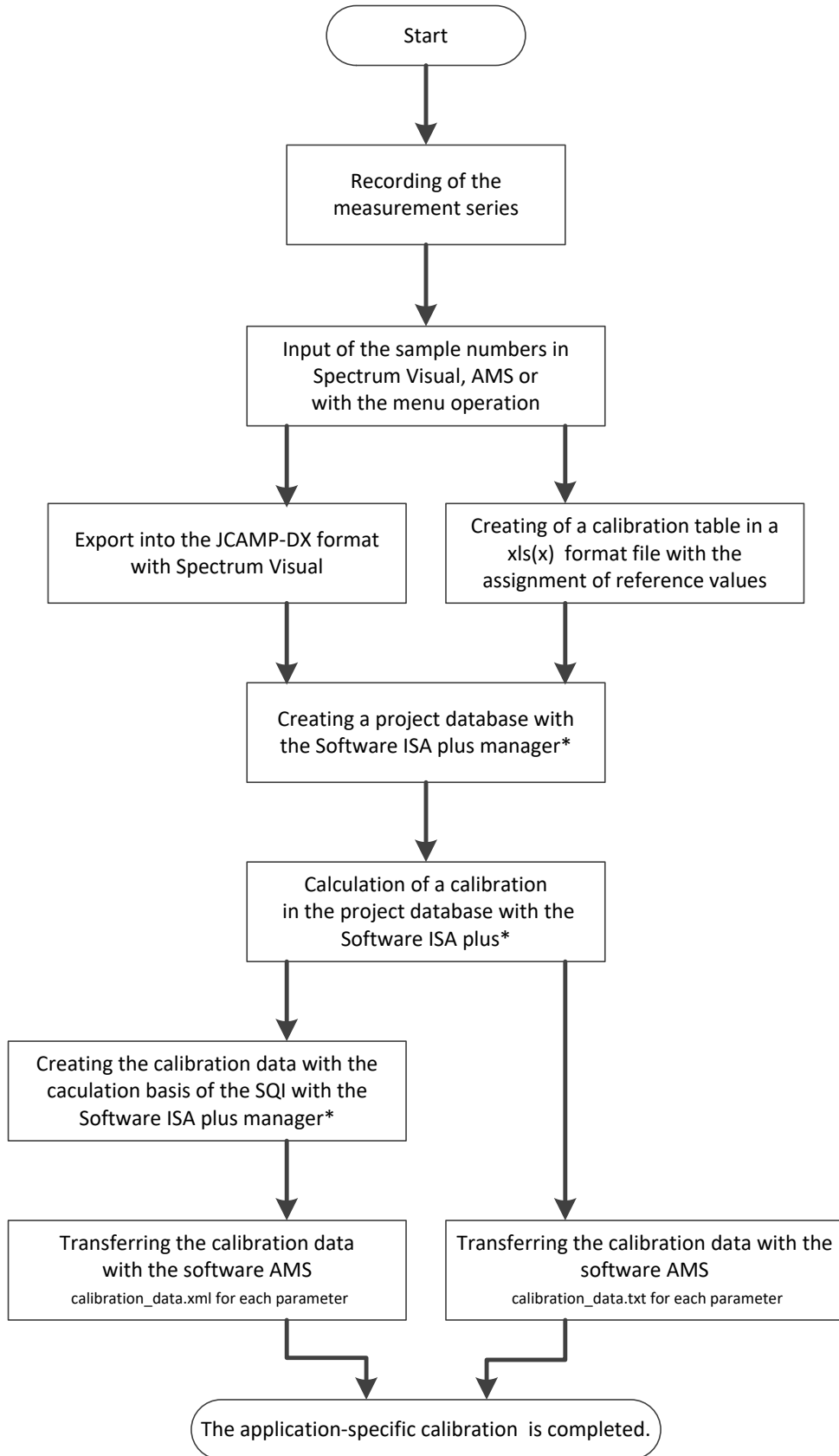

\* If you do not have the software *ISA plus manager/ISA plus*, please contact GO Systemelektronik.

### 4.3.3 Recording of Test Series

A reference value pair consists of the chemical analysis of a sample and spectral data that were recorded as time-and place simultaneously with the taking of the sample.

Please also ensure that the reference value pairs are spread as evenly as possible over the entire expected measuring range.

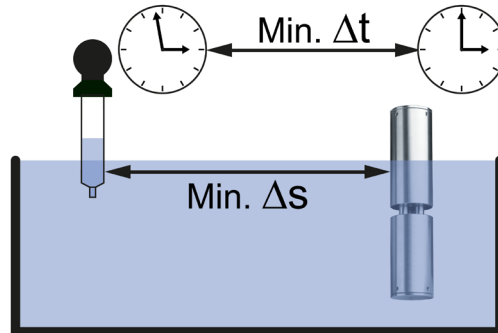

It is appropriate here to choose the measurement interval of the spectrometer to a value of  $\geq 60$  s.

It is also advisable to measure for a sample collected 2 to 3 spectra, so a comparison can indicate deviations from pollution, air bubbles, etc.

see also *Appendix – ISA Parameter Calculation*

**i** The terms **sample number** and **sample name** have the same meaning here.

### 4.3.4 Creating a Calibration Table

The calibration table must be stored in the xls- or xlsx-format.

**The design of a calibration table:**

	Parameter Unit	Parameter Unit	...	Parameter Unit
Sample number 1	value 11	value 12	...	value 1n
Sample number 2	value 21	value 22	...	value 2n
Sample number 3	value 31	value 32	...	value 3n
Sample number 4	value 41	value 42	...	value 4n
...	...	...	...	...
Sample number n	value n1	value n2	...	value nn

**Sample number 1 to n:** as setting "Sample no." in Spectrum Visual, AMS or menu operation

**Parameter:** as setting "Parameter" in the Sensor Setup Window

**Unit:** as setting "Unit" in the Sensor Setup Window

**the exception is the slash “/”, instead use a post positioned -1 (mg/l ⇒ mg l-1)**

**i Note:** The decimal separator of the values can be both the comma and the point. Therefore, use comma and point in the values only as decimal separators, not as thousands separators.

### 4.3.5 Application example of TOC/COD in process water

#### Receiving the series of measurements

For the application-specific calibration 5\* pairs of reference values were taken. A reference value pair consists of the TOC-laboratory analysis values, the COD-laboratory analysis values and the associated spectral data. This is therefore a multi-parameter calibration.

These spectral data were recorded two times to detect fault-related differences. For the calibration is only used in each case one spectrum.

#### Sampling TOC/COD 26.05. and 27.05.

Sample no.	Dilution	Sampling point	Time	TOC-Lab [mg/l]	COD-Lab [mg/l]	Remark
TC1	RO-Water	12:45	09:15 – 12:55	1.56	7.00	26.05.
TC2	C-clean	13:45	13:00 – 13:48	7.29	49.00	26.05.
TC3	C- clean 1:2 C-unclean	15:45	14:55 – 15:50	19.70	113.00	26.05.
TC4	C- clean 1:3 C-unclean	07:45	07:19 – 07:50	23.40	118.00	27.05.
TC5	C-unclean	08:30	07:54 – 08:35	27.10	141.00	27.05.

RO = Reverse Osmosis C = Concentration

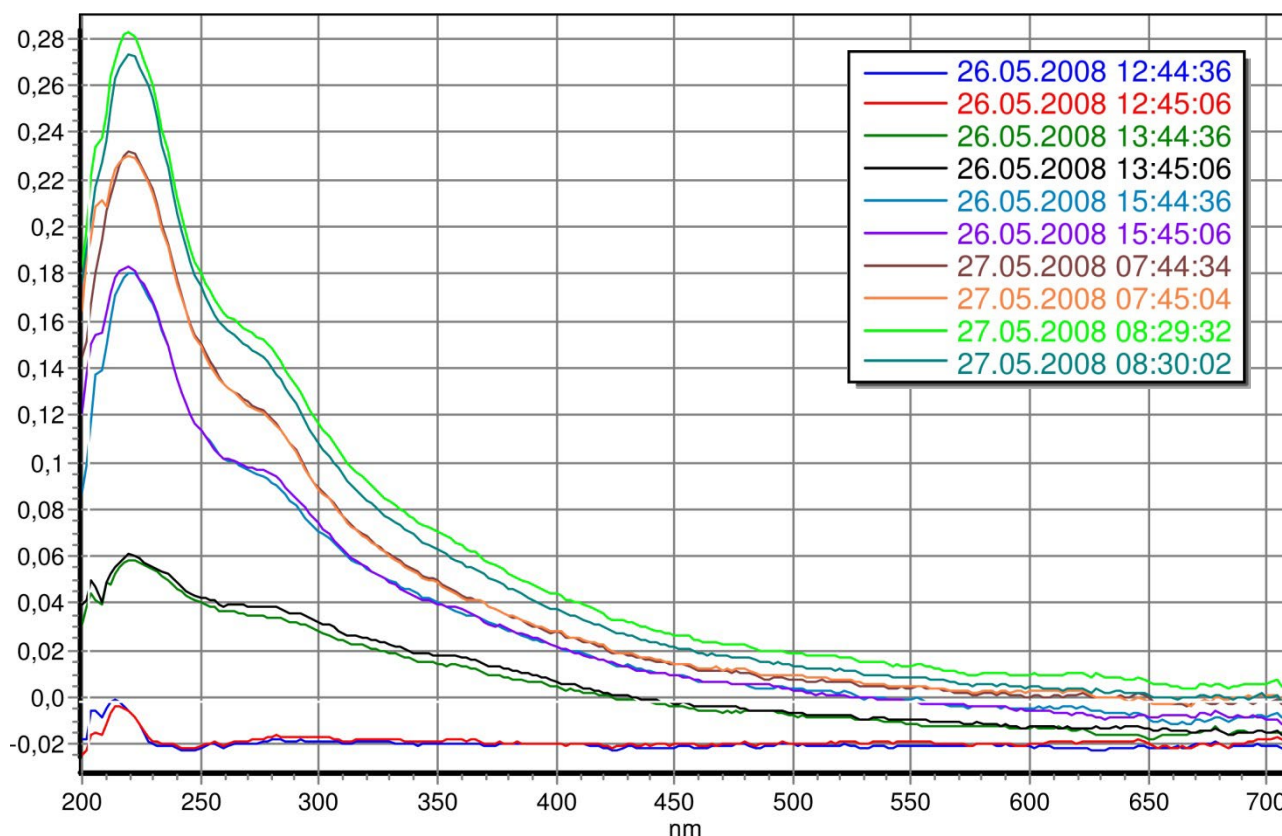

\* Actually at least 25 pairs of reference values are necessary, for better clarity here are only 5 pairs of reference values presented.



In this example, the sample numbers are entered in the program **Spectrum Visual**.

**i Note:** It is often useful to enter the sample numbers directly during the spectra recording using the **BlueBox menu operation** (see *Manual ISA Spectrometer* there 8.2 *The Service Menus*) or the **AMS program** (see *Manual ISA Spectrometer* there 9.2.2.4 *Button Bar Functions* there *Save as sample*).

### Input of 5 Sample numbers in Spectrum Visual

A complete description of the program **Spectrum Visual** you get in the *Manual ISA Spectrometer* there 11 *Spectrum Visual*.

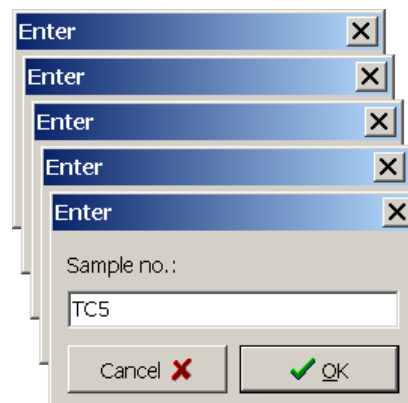

### Selecting spectra and export of the spectra data in a JCAMP-DX-file

**i Note:** Click on  selects all entries that have reference values and/or sample numbers.

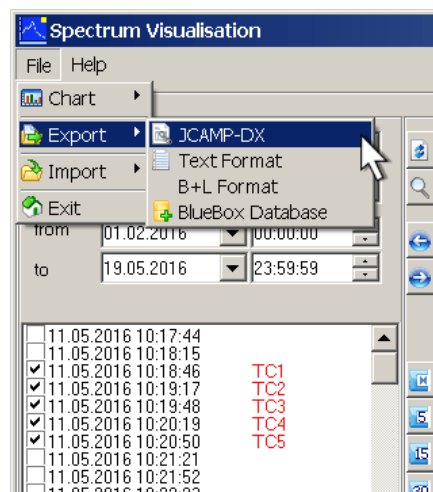

### Combining the reference value pairs in the calibration table in the xls- or xlsx-format

TC.xls - OpenOffice Calc			
	A	B	C
1		TOC mg l-1	CSB mg l-1
2	TC1	1,56	7
3	TC2	7,29	49
4	TC3	19,7	113
5	TC4	23,4	118
6	TC5	27,1	141
7			

### Calculation of the calibration data

The **calculation** of the calibration data is carried out with the software ISA plus in the project database generated by the software ISA plus manager. The software ISA plus manager in turn generates then for each parameter calibration files in the **xml-format** (with SQI) from the project database. Calibration files for each parameter in the **txt-format** (without SQI) are generated by the software ISA plus directly from the project database. Overall sequence see 4.3.1 *Overview Application-Specific Calibration* and 4.3.2 *Flow Chart of the Application-Specific Calibration*

## Transferring of the calibration data

Open the sensor setup window of the parameter (this example CSB). Then open the **configuration window of the parameter** with click on <Config>.

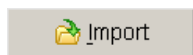
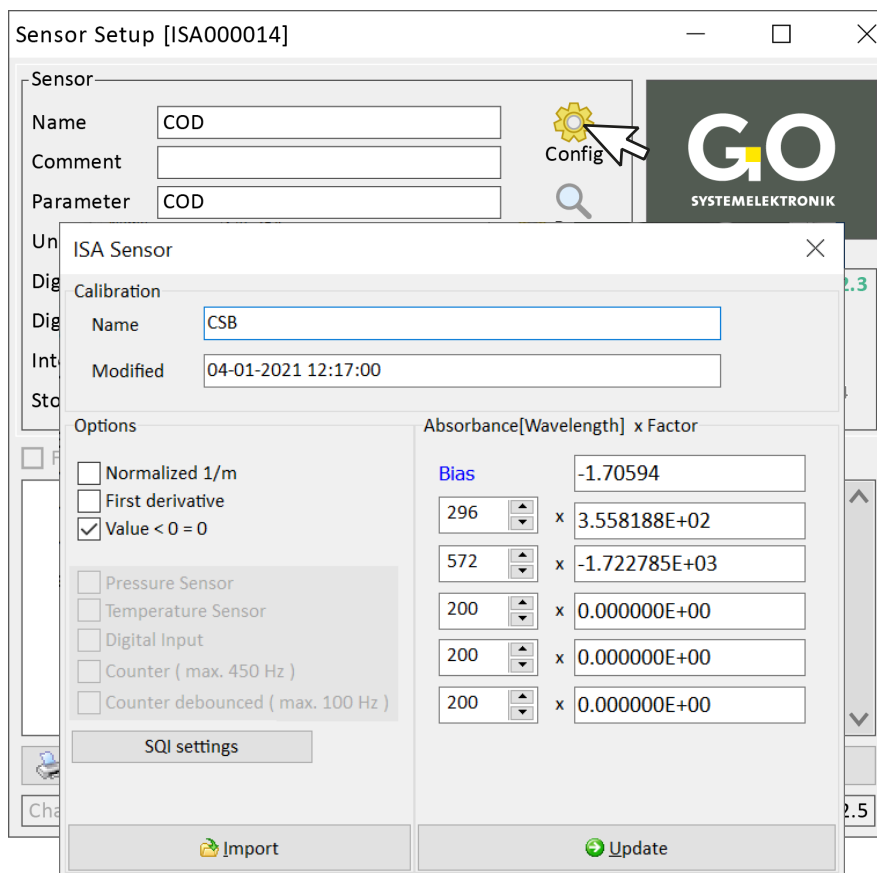

Open a selection window for an ISA calibration file in the xml-format (calibration with SQI) or in the txt-format (calibration without SQI) and imports the calibration data.



Transmits the settings via the BlueBox to the spectrometer module.

**The application-specific calibration is completed.**

## 4.4 Reference Measurement at the BlueBox R1 and BlueBox RS Display Firmware Version 5.01.31

### 4.4.1 Call-Up at Calibration Start Display

 CALIBRATION ^

 Service Display > Intensity Configuration > Calibration

◀ Switches back to the Service Display.

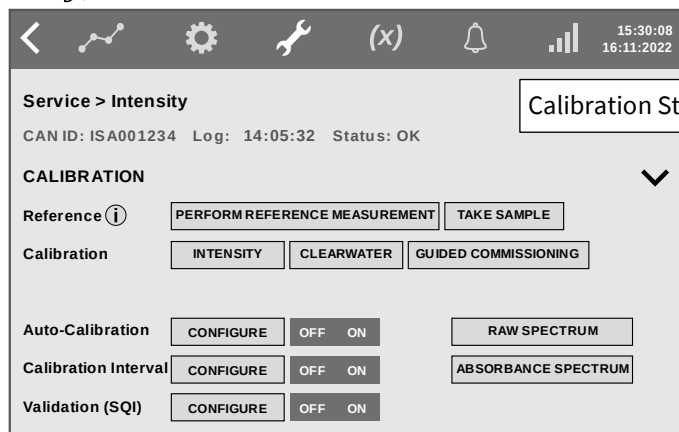

✓ Switches back to the Selection Display

👉 Tap on a rectangle.

**Reference** PERFORM REFERENCE MEASUREMENT Leads to the Sample Table, see 4.4.2 Sample Table

TAKE SAMPLE Leads to the sample taking with the current spectrum. see 4.4.4 Take Sample with Current Spectrum

### 4.4.2 Sample Table

PERFORM REFERENCE MEASUREMENT 4.4.1 Call-Up at Calibration Start Display

◀ Switches back to the Calibration Start Display.

**i** Opens an info field. see 4.4.4

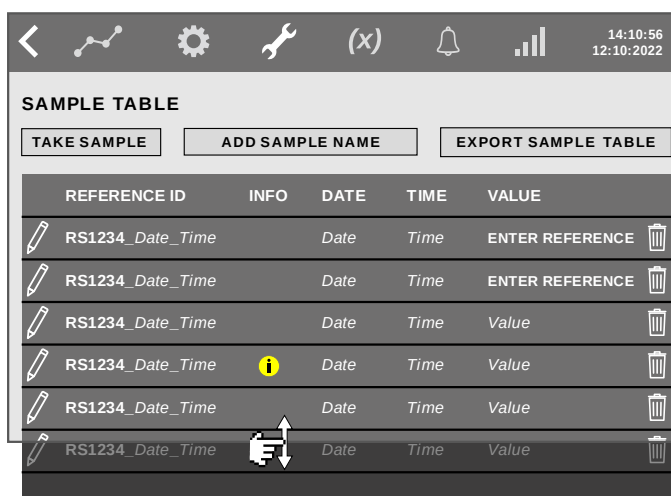

TAKE SAMPLE

Starts the Reference Measurement. see 4.4.3

ADD SAMPLE NAME

Taking a sample with a spectrum defined by date and time. see 4.4.5

EXPORT SAMPLE TABLE

Exports the Reference Values Table as csv-file, jdx-file (JCAMP-DX\* format) and json-file to a connected USB stick. You can use the csv-file as calibration table together with the jdx-file to create a project database with the Software ISA plus manager.



Switches to the sample editing display. see 4.4.6



**ENTER REFERENCE**

Switches to the entry of the reference value of the sample. After an entry, the entered value appears here.  VALUE



Deletes the corresponding Reference Value.

\* JCAMP-DX is the standard format family for spectral data exchange.

### 4.4.3 Reference Measurement

**TAKE SAMPLE** 4.4.2 Sample Table

A spectrum is captured. If the spectrum is captured successfully, the following display appears.

◀ Switches back to the Sample Table.

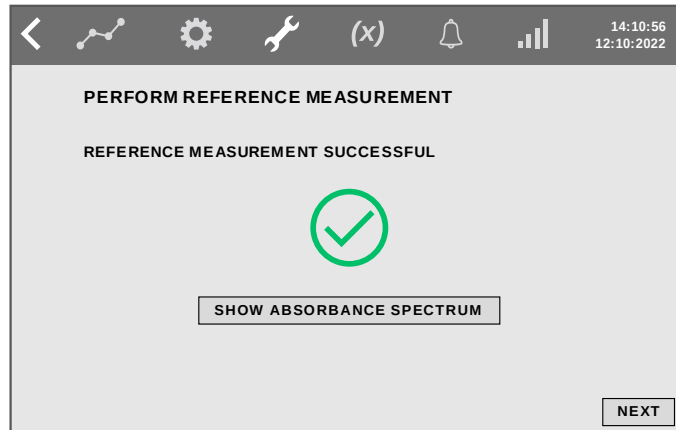

**SHOW ABSORBANCE SPECTRUM**

Switches to the display of the absorbance spectrum of the allocated spectrum.

**NEXT**

Switches to the sample taking with the current spectrum. see 4.4.4 Take Sample with Current Spectrum

### 4.4.4 Sampling with the Last Captured Spectrum

**TAKE SAMPLE** > **NEXT** 4.4.3 Reference Measurement

◀ Switches to the Sample Table.

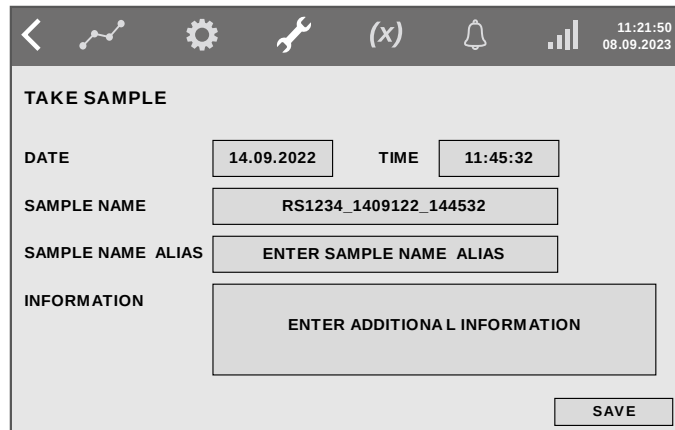

**DATE TIME** Date and time of the spectral reference measurement

**SAMPLE NAME** Automatically generated sample name.

**SAMPLE NAME ALIAS** Switches to the input of an alias name of the sample name.

**INFORMATION** Switches Leads to the entry for the  info field in the Sample List.

**SAVE**

Saves the entry and switches to the Sample List.

You enter the corresponding reference value in the Sample List with  VALUE. see also 4.4.6

### 4.4.5 Add Sample via Date and Time of the Measurement Recording

ADD SAMPLE NAME

#### 4.4.2 Sample Table

◀ Switches back to the Sample Table.

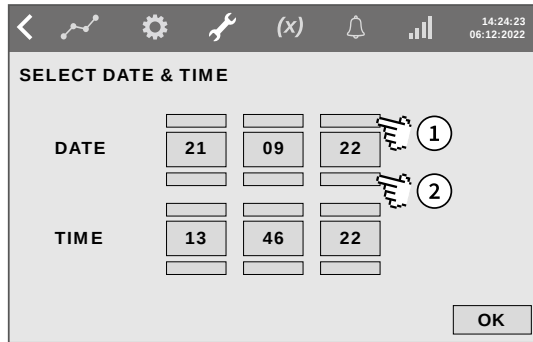

① One up

② One down

Sample taking with a spectrum defined by date and time.

OK

Saves the sample and switches back to the Sample List.

The corresponding reference value and other entries are entered in the sample edit display. see 4.4.6 Reference value entry also with  VALUE in the Sample List.

### 4.4.6 Edit Sample



#### 4.4.2 Sample Table



Switches back to the Sample Table.

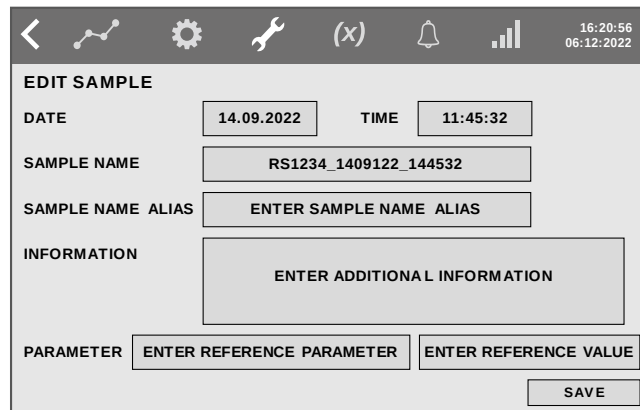

**DATE TIME**

Date and time of the measurement

**SAMPLE NAME**

Automatically generated sample name

**SAMPLE NAME ALIAS**

Leads to the entry of an alias name for the sample name.

**INFORMATION**

Leads to the entry for the  info field in the sample table.

ENTER REFERENCE PARAMETER

Here you create a list of units of measurement; from this list, units of measurement (REFERENCE PARAMETER) are assigned to reference values.

- **Create list entry:** Tap + to open the standard alphanumeric input display. Enter the unit of measurement here.
- **Assign list entry:** Tapping on a list entry assigns the unit of measurement and closes the display.

CANCEL

Closes the display without assignment.



Deletes the list entry.

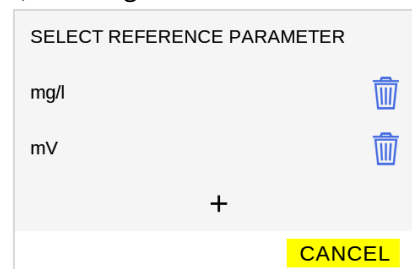

ENTER REFERENCE VALUE

Leads to the input of the reference value.

SAVE

Saves the sample and switches back to the sample table.

## 5 Maintenance

### 5.1 Maintenance Notes

Prerequisite for fault-free operation is a proper installation of the sensor head in the measurement site, as well as the regular inspection of installation conditions. During inspection, a cleaning of the ISA system should be performed, with short enough intervals corresponding to the external influences on the system.

**The fibre optic cable must not be bent or flexed with a radius less than 40 mm. Also, the sensor head may not be hung on the sensor head cable, for this purpose the eyebolts at the sensor head are provided.**

Here regular stress can cause damage to the protective jacket, which can lead to failure of the spectrometer. In extreme loads due to media with temperatures above 80 °C or pH values of less than 4 or greater than 10, a protection of the fibre and particularly the fibre connection should be ensured by a suitable fitting. This will ensure the uninterrupted operation of the system even in extreme media over long time intervals.

**When installing the sensor head it is basically to act in such a way, that the fibre connector is not subjected to mechanical load.**

**The electronics housing must be mounted so that it is neither exposed to direct sunlight, nor direct rain nor snow. Direct sunlight can lead to extreme temperatures, which will reduce the life of the electronic components significantly.**

### 5.2 Maintenance Recommendations

Although the ISA sensor head is very easy to maintain, the following points must be noted, so that the ISA sensor head is always ready to use and gives reliable results:

- ▶ Regular manual cleaning of the glass panes in the measurement path, see 5.3 *Cleaning the Sensor Head*
  - ▶ Clear water calibration every 1 – 3 months
  - ▶ Yearly or half-yearly inspection of the system by GO authorized service personnel
  - ▶ Ensure that the glass plates of the sensor head are always in fluid. A drying out of a glass plate will lead to a build up of film (depending on the type of fluid) and then a cleaning is necessary.
  - ▶ Use of compressed air cleaning  
The spectrometer should not be used without compressed air cleaning.
- i Note:** The measured medium flows into the compressed air duct. If left there for a long time, it can clog the compressed air duct. When taking the sensor head out of service for a longer time, blow out any residues in the compressed air duct briefly.

### 5.3 Cleaning the Sensor Head

Due to the automated compressed air cleaning of the measurement path, the ISA achieves very long service lives and maintenance intervals. Nevertheless, it is necessary to clean the glass panes in the measurement path regularly by hand.

**The necessary cleaning interval may vary significantly depending upon location, given dirt level and use of compressed air cleaning (1 week to 3 months).**

A slow, continuous change of SAC254 is an indicator of increasing impurity of the glass panes.



**Caution:** Never use strong organic solvents (e.g. acetone), strong acids and bases, or abrasive cloths, brushes and steel wool!



**Please note:**  
Each unauthorized disassembling of the sensor head will void your warranty.

Take care when cleaning on any adhering particles; these should be removed with compressed air before using a brush or a cloth, so that the glass panes do not scratch when cleaning.



Older sensor heads have glass plates made of quartz glass. New sensor heads have glass plates made of sapphire glass: Sapphire glass is more resistant than quartz glass.

Year of manufacture  $\leq 2018$   $\Rightarrow$  Quartz glass      Year of manufacture  $\geq 2019$   $\Rightarrow$  Sapphire glass  
Year of Revision  $\geq 2019$   $\Rightarrow$  Sapphire glass

In case of doubt please contact GO Systemelektronik.



**Caution:** Quartz glass plates are not suitable for contact with strong organic solvents (e.g. acetone), strong acids and strong bases.





## 6 Factory Service

### Service at least every 5 years:

e.g. drinking water, environment, sewage treatment plant emissions, water without special loads such as high suspended solids or other solutes

Typical ⇒ fluid temperatures between 0 to 60 °C, pH values between pH 6 and 8

### Service at least every 2 years:

Typical ⇒ fluid temperatures regularly exceed 60 °C to a maximum of 80 °C, pH values between pH 4 and 10

### Service in extreme conditions:

At temperatures frequently higher than 80 °C and pH values of less than pH 4 and higher than pH 10 the service interval should be reduced further and the optic fibre connection should be protected.

At pH values less than pH 2 and higher than pH 12, the optic fibre connection must be protected definitely.

Here, during normal cleaning, there is a thorough review of the tightness of the armature and the condition of the parts located in the measured fluid must be carried out.

Especially with high proportions of sand or similar in the measured medium, the optical windows can be stressed higher and so may need to be changed annually.

Fluoride attacks glass; on suspicion of fluoride in the water please first consult the operator.

On the work carried out within the scope of factory service, GO Systemelektronik gives a warranty of 12 months on the total refurbished sensor head.

Precondition for the warranty is a use according to the product intention. This includes among others, that operating procedures and notes are followed as described in this manual.

The lifetime of the xenon lamp and the sensor head cable is greater than 5 years.

### Overview:

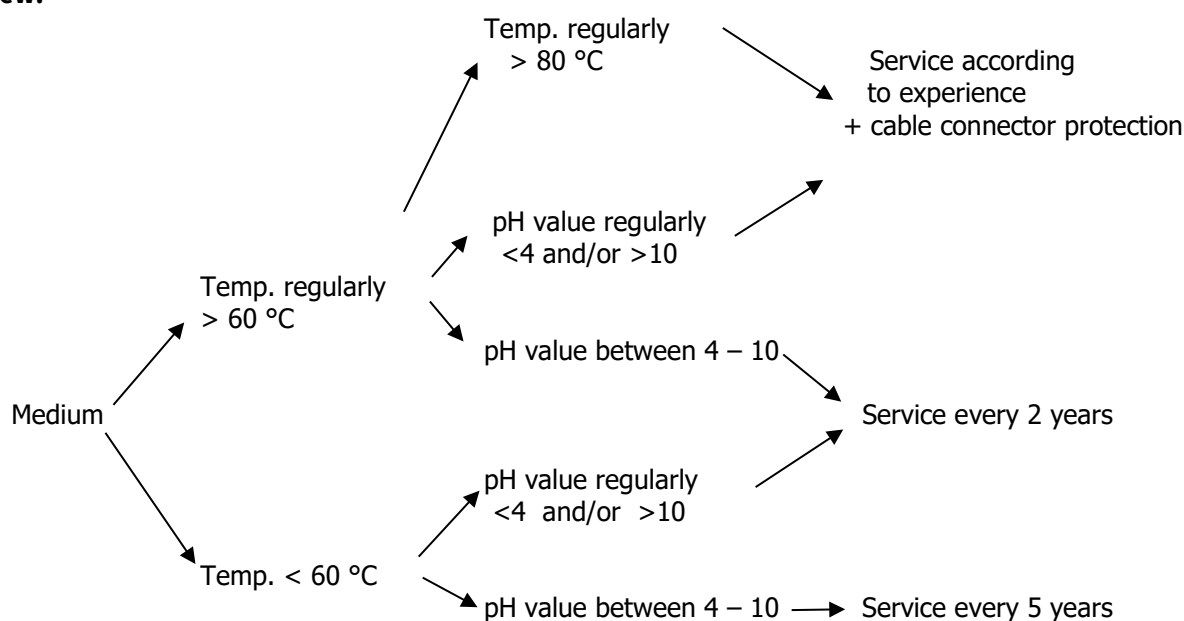

## 7 Process Spectrometer (Flow Through Unit) Overview

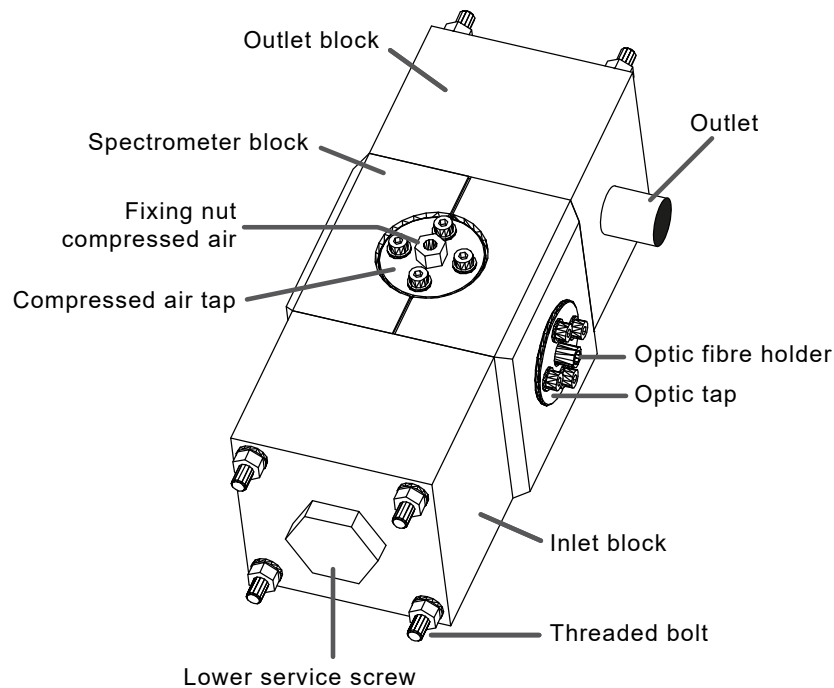

**i** Older flow through units have glass plates made of quartz glass. New flow through units have glass plates made of sapphire glass: sapphire glass is more resistant than quartz glass.  
 Year of manufacture  $\leq 2018 \Rightarrow$  Quartz glass      Year of manufacture  $\geq 2019 \Rightarrow$  Sapphire glass  
 Year of Revision  $\geq 2019 \Rightarrow$  Sapphire glass  
 In case of doubt please contact GO Systemelektronik.



**Caution:** Quartz glass plates are not suitable for contact with strong organic solvents (e.g. acetone), strong acids and strong bases.

### 7.1 Commissioning and Base Calibration

The process spectrometer is delivered clean and ready to use. An initial cleaning is not necessary.

If you have installed the measuring system, turn on the power to the BlueBox. During initialization, the BlueBox recognizes the spectrometer automatically.

At the first start-up you have to perform a **base calibration** of the measurement system.

- The base calibration is required for to set the measuring range of the spectrometer optimally.
- The digital values (counts) of the raw spectra are influenced by three factors:
  - the length of the measurement path
  - the number of light flashes per single measurement (Intensity)
  - the measurement medium

**i Note:** Any change in the measurement set-up requires a recalibration.

### Base calibration:

The intensity calibration of the process spectrometer differs from the intensity calibration of the ISA in that the setting of the measurement path length is omitted due to the lack of possibility.

The base calibration consists of 2 steps:

1. Perform the intensity calibration. see 4.2.5 Intensity Calibration (Light Intensity)
2. Perform the clear water calibration. see 4.2.6 *Clear Water Calibration with the program AMS*

The basic calibration is followed by the application-specific calibration. see 4.3 *Application-Specific Calibration*

## 7.2 Maintenance

The process spectrometer is treated as the ISA Spectrometer.

The difference is in the manual cleaning of the Process Spectrometer.

### 7.2.1 Maintenance Recommendations

The following points must be noted, so that the process spectrometer is always ready to use and gives reliable results:

- ▶ Clear water calibration every 1 – 3 months
- ▶ Yearly or half-yearly inspection of the system by GO authorized service personnel
- ▶ Ensure that the glass plates of the spectrometer are always in fluid. A drying out of a glass plate will lead to a build up of film (depending on the type of fluid) and then a cleaning is necessary.
- ▶ Use of compressed air cleaning  
The spectrometer should not be used without compressed air cleaning.

**!** Use only oil-free compressors.

- i Note:** The measured medium flows into the compressed air duct. If left there for a long time, it can clog the compressed air duct. When taking the sensor head out of service for a longer time, blow out any residues in the compressed air duct briefly.



**Caution:** Do not kink the Optical fibre!

### 7.2.2 Cleaning the Process Spectrometer

If cleaning without dismounting the spectrometer optic does not have the desired result, the spectrometer optics must be cleaned in the dismantled state.



**Switch off the compressed air cleaning.**

#### 7.2.2.1 Cleaning without Dismounting the Spectrometer Optic

1. Fill the process spectrometer with household cleaner in tap water for about 5 minutes. Then clean the inside of the spectrometer through a service screw with a matching soft bottle brush. Empty the spectrometer.
2. Rinse the spectrometer with warm tap water.
3. Prepare a warm (approx. 50 °C) citric acid solution (concentration 2 – 3 %) with tap water. Fill the spectrometer for 10 – 15 minutes with this solution. Then clean the inside of the spectrometer in this solution through a service screw with a matching soft bottle brush. Empty the spectrometer.
4. Use a grease-free alkaline laboratory glass cleaner to prepare a warm (approx. 50 °C) solution (concentration 2 – 3 %) with tap water. Fill the spectrometer with this solution for 10 – 15 minutes. Empty the spectrometer.
5. Fill the spectrometer with tap water for approx. 1 minute. Turn on the compressed air cleaning and briefly blow out all residues of the vents
6. Turn off the compressed air cleaning again.
7. Rinse the spectrometer with tap water

#### Completion:

8. Fill the spectrometer with double distilled water.
9. Perform a clear water calibration. (see 4.2.6 following)
10. Check the absorbance spectra recorded from here on. If deviations from 240 nm and /or drift greater than  $\pm 0.008$  can be detected, go back to step 7.
11. Turn on the compressed air cleaning, after you have placed the sensor to the measurement position.

**Please note:** The glass panes are only clean, when the signal from the raw spectra clearly distinguishes between 10 and 30 of the X-axis.

If the signal from the raw spectra between 10 and 30 is below 500 counts, the glass panes are not clean.



#### **Only measure with clean glass panes!**

Error message on the display:

Attention

Please clean spectrometer!

Go back to step 3.

**If repeated cleanings fail, you have to clean the optic at the removed device.**

**Improper handling at the installation and removal can damage the device optic!**

7.2.2.2 Cleaning with Dismounting the Spectrometer Optic

**Demounting the spectrometer optic:** The extractor required in step 5 and 6 is a M8 threaded bolt, or similar.

1. Loosen the fibre cable holder with the knurled-head bolt.

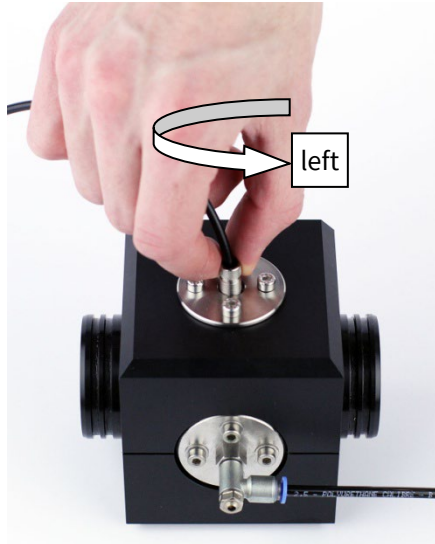

2. Pull out the fibre cable carefully with the fibre cable holder.

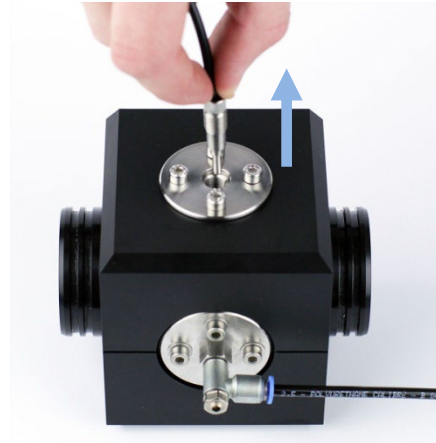

Pay attention to the O-ring!

3. Protect the fibre optic cable with a protective cap or similar.



4. Loosen the Allen screws of the optic tap.

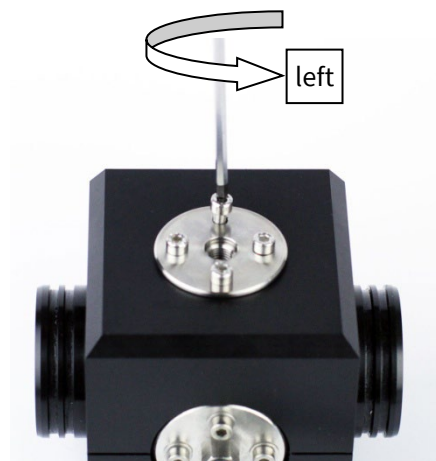

5. Screw the thread of the extractor into the thread of the lens carrier.

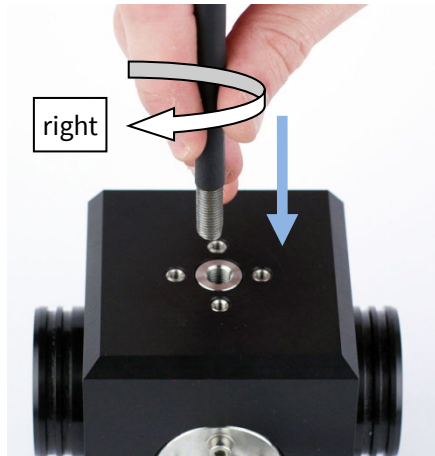

6. Pull the optical carrier at the extractor carefully out. Pay attention to the O-rings!





**Caution: No dirt or liquid shall enter the inside of the lens carrier!**  
Seal the lens carrier appropriate.



**Caution:** Never use strong organic solvents (e.g. acetone), strong acids and bases, or abrasive cloths, brushes and steel wool!



**Please note:**  
Each unauthorized disassembling of the sensor head will void your warranty.

**!** Take care when cleaning on any adhering particles; these should be removed with compressed air before using a brush or a cloth, so that the glass panes do not scratch when cleaning.

### Cleaning:

1. Rinse the outside of the glass pane with warm tap water.
2. Prepare a warm (approx. 50 °C) citric acid solution (concentration 2 – 3 %) with tap water. Then immerse the outside of the glass panes for 10 – 15 minutes into this solution. Then clean the outside of the glass pane in this solution with a soft brush or a household cloth.
3. Use a grease-free alkaline laboratory glass cleaner to prepare a warm (approx. 50 °C) solution (concentration 2 – 3 %) with tap water. Immerse the outside of the glass pane for 10 – 15 minutes in this solution.
4. Rinse the outside of the glass pane with tap water.
5. Immerse the outside of the glass pane for approx. 1 minute in tap water.
6. Rinse the outside of the glass pane in tap water.
7. Repeat the cleaning at the second optical carrier.

### Completion:

9. Mount the optic carriers in the reverse order of disassembly.
10. Rinse the spectrometer with DI-water.
11. Fill the spectrometer with double distilled water.
12. Perform a clear water calibration. (see 4.2.6 following)
13. Check the following absorbance spectra. If deviations from 240 nm and /or drift greater than  $\pm 0.008$  can be detected, go back to step 10.
14. Turn on the air cleaning, after you have placed the sensor to the measurement position.

## Process Spectrometer - Factory Service

### 7.3 Factory Service

#### Service at least every 5 years:

e.g. drinking water, environment, sewage treatment plant emissions, water without special loads such as high suspended solids or other solutes

Typical  $\Rightarrow$  fluid temperatures between 0 to 60 °C, pH values between pH 6 and 8

#### Service at least every 2 years:

Typical  $\Rightarrow$  fluid temperatures regularly exceed 60 °C to a maximum of 80 °C, pH values between pH 4 and 10

#### Service in extreme conditions:

At temperatures frequently higher than 80 °C and pH values of less than pH 4 and higher than pH 10 the service interval should be reduced further.

Especially with high proportions of sand or similar in the measured medium, the optical windows can be stressed higher and so may need to be changed annually.

Fluoride attacks glass; on suspicion of fluoride in the water please first consult the operator.

On the work carried out within the scope of factory service, GO Systemelektronik gives a warranty of 12 months on the total refurbished process spectrometer.

Precondition for the warranty is a use according to the product designation. This includes among others, that operating procedures and notes are followed as described in this manual.

The lifetime of the xenon lamp and the fibre optic cables is greater than 5 years.

#### Overview:

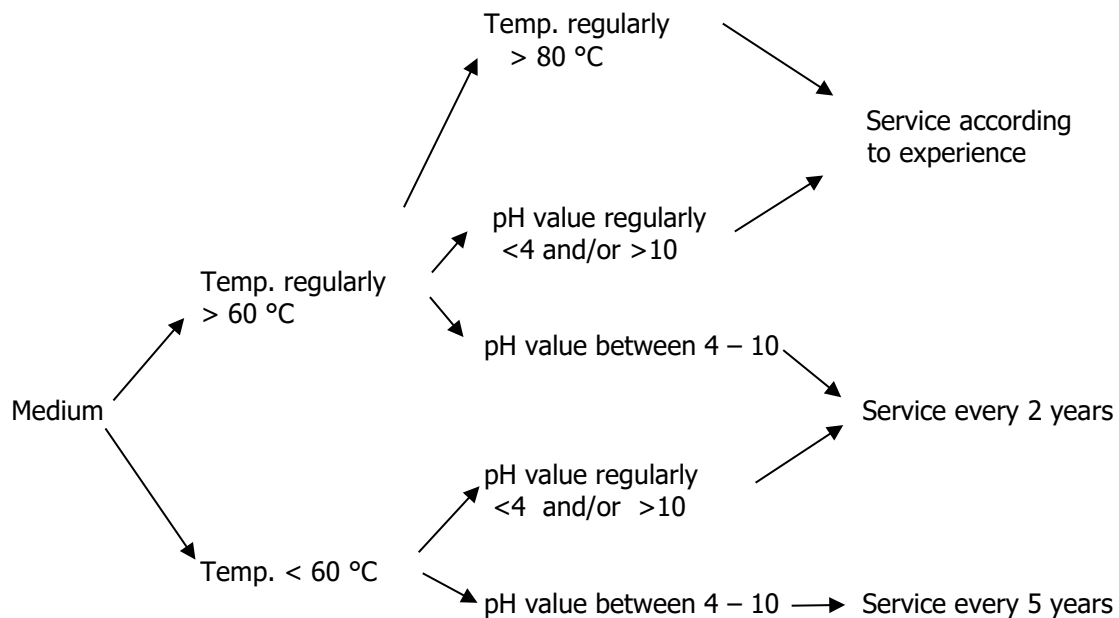

## 8 BlueScan

Operation, commissioning, maintenance and service are almost identical to those of the ISA Spectrometer (see chapters 3 to 6), except for the setting of the measurement gap (see 8.1 *Setting the Measurement Gap Length*).

**Differences to the ISA sensor head:** The BlueScan sensor head is particularly compact; the measurement gap is set exclusively with spacer discs.

The products of GO Systemelektronik are constantly being developed, therefore deviations between this manual and the delivered product can result. Please understand that no legal claims can be derived from the contents of this manual.

**Sensor head BlueScan** Article-No. 461 6008

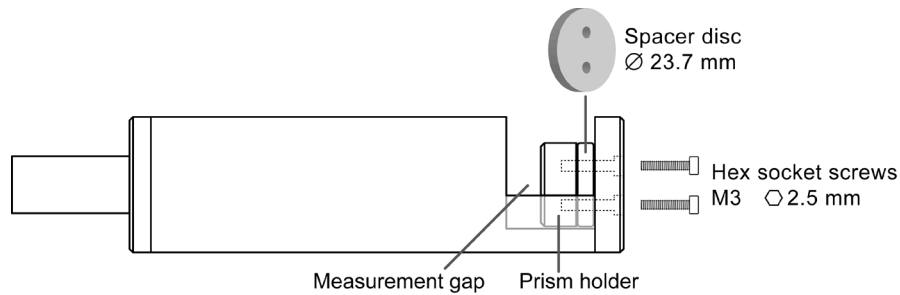

Setting the measurement gap length see next page



### 8.1 Setting the Measurement Gap Length

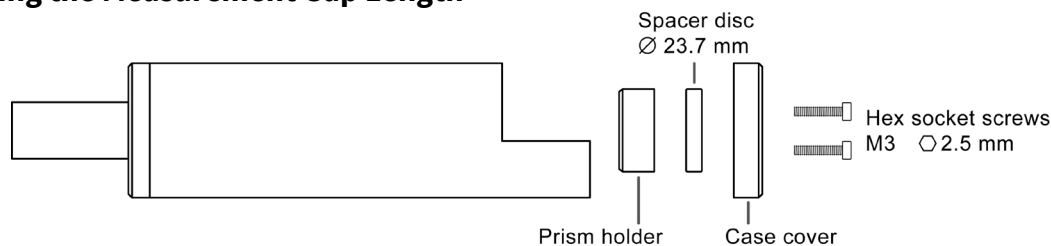

Sensor head BlueScan – Measurement gap setting with the spacer discs

**i** Measurement path = 2x Measurement gap

Meas. gap [mm]	Disc thickness [mm]						Screws M3 DIN 912 A4	
	0,5	1	2	2	5	10	Length [mm]	Article-No.
14.5							6	335 0351
14	x							
13.5		x					8	335 0359
13	x	x						
12.5			x					
12	x		x					
11.5		x	x				10	335 0353
11	x	x	x					
10.5			x	x				
10	x		x	x			12	335 0354
9.5					x			
9	x				x			
8.5		x			x			
8	x	x			x		14	335 0384
7.5			x		x			
7	x		x		x			
6.5		x	x		x			
6	x	x	x		x		16	335 0377
5.5			x	x	x			
5	x		x	x	x			
4.5						x		
4	x					x	18	335 0375
3.5		x				x		
3	x	x				x		
2.5			x			x		
2	x		x			x	20	335 0385
1.5		x	x			x		
1	x	x	x			x		
0.5			x	x		x		



The procedures described here require qualified personnel.

### General

Parameters calculated by ISA spectral data can achieve an accuracy of 5 % (typical 5 % – 10 %) if good calibration procedures are followed.

In practice, the accuracy can vary by a change of water matrix. If the water matrix has high variability, for example day/night or seasonal changes, this has to be analysed and samples should be obtained from these different water matrixes. In difficult places the system can cater for the different water matrix with special calibrations. Changes in water matrix can be detected by other parameters such as conductivity, pH, temperature etc.

1. The accuracy of spectral data calculated parameters is always influenced by the quality of calibration. A higher number of calibration points will have the result of a more accurate calibration!
2. The calibration references have to cover all the measuring range. For calibration with good quality a minimum of 20 sample points should be included in the calibration.
3. The analytical method and quality in procedure is one of the most important factors for accuracy of the calculation! The accuracy of the ISA parameter calibration is dependent upon the specific accuracy of the chemical method for the parameter. That means that the evaluation of the value has to be made with the same method and the result is dependent on variations in both. The accuracy of the laboratory analysis has to be in best case ten times higher than the accuracy defined for the parameter calibration!
4. The calibration has to be tested and verified over a longer time, for example one week. By this long term test the stability of the water matrix and by this, the stability of the calibration can be improved.
5. For measurements with high standard in accuracy the maintenance of the system has to be defined. In defined time loops the system has to be cleaned and clear – water recalibrated. The maintenance interval is directly influenced by the measurement location and can vary from weeks to months.

### Practical Tips

With reference to point 3 above, one of the most important things to remember when performing a calibration of the ISA against different parameters is how quickly and accurately the samples are analysed by a laboratory for their COD/BOD/TSS values once you have obtained the samples' optical spectrum with the ISA. For example, it may be very important that samples are kept cool, or away from sunlight, so that biological parameters do not deteriorate!

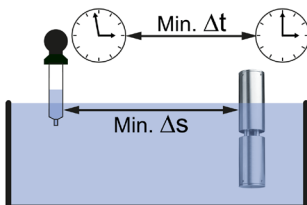

Please note:

- The time between sampling and spectrum capture must be minimised ( $\Delta t$ ).
  - The distance between the sampling position and the position of the ISA sensor head must be minimised ( $\Delta s$ ).
- Please also ensure that the reference value pairs are spread as evenly as possible over the entire expected measuring range. Example: If you want to measure COD in the range of 0 – 2000mg/l then take the samples so that the COD values are spread over the entire range from 0 – 2000mg/l and are not concentrated in the range of 300 – 700 mg/l.

If you can only obtain samples from a small section of the measuring range, then as a last resort please try to enrich or dilute the samples to obtain higher or lower concentrations.

Example: Enrich the normal sample with possible sources of contamination to increase the parameter concentration.

Example: Dilute the sample with normal drinking water from the area, to reduce the parameter concentration.

## Tips for High Accuracy Application-Specific Calibrations

### Sampling and Spectra Recording

Except in special cases, sample extraction and the obtaining of spectra for calibration purposes shall be done according to one of the following three approaches.

#### Approach 1:

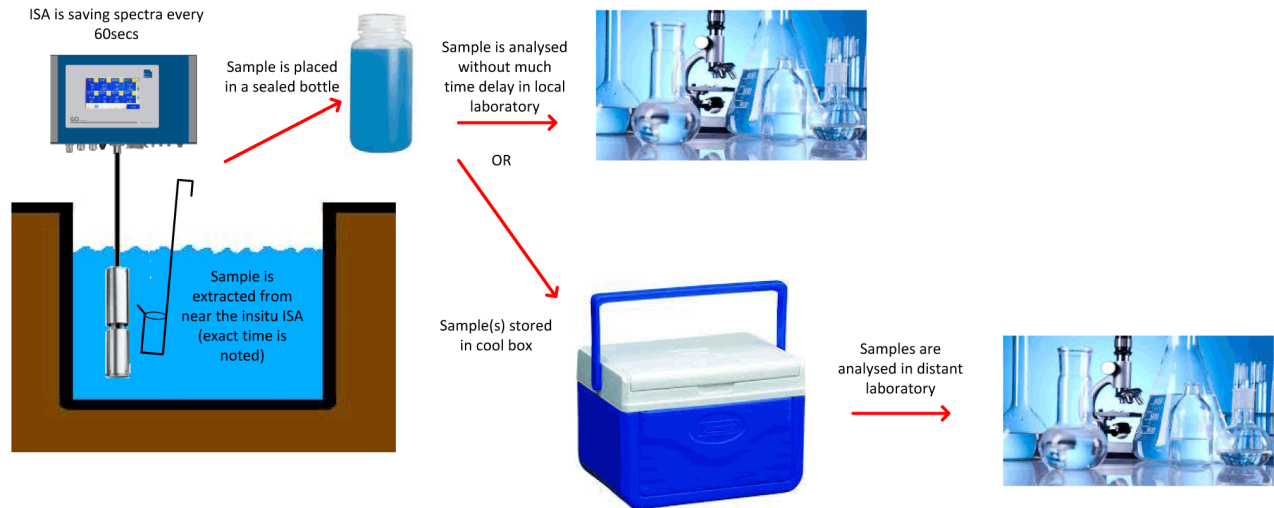

#### Approach 2:

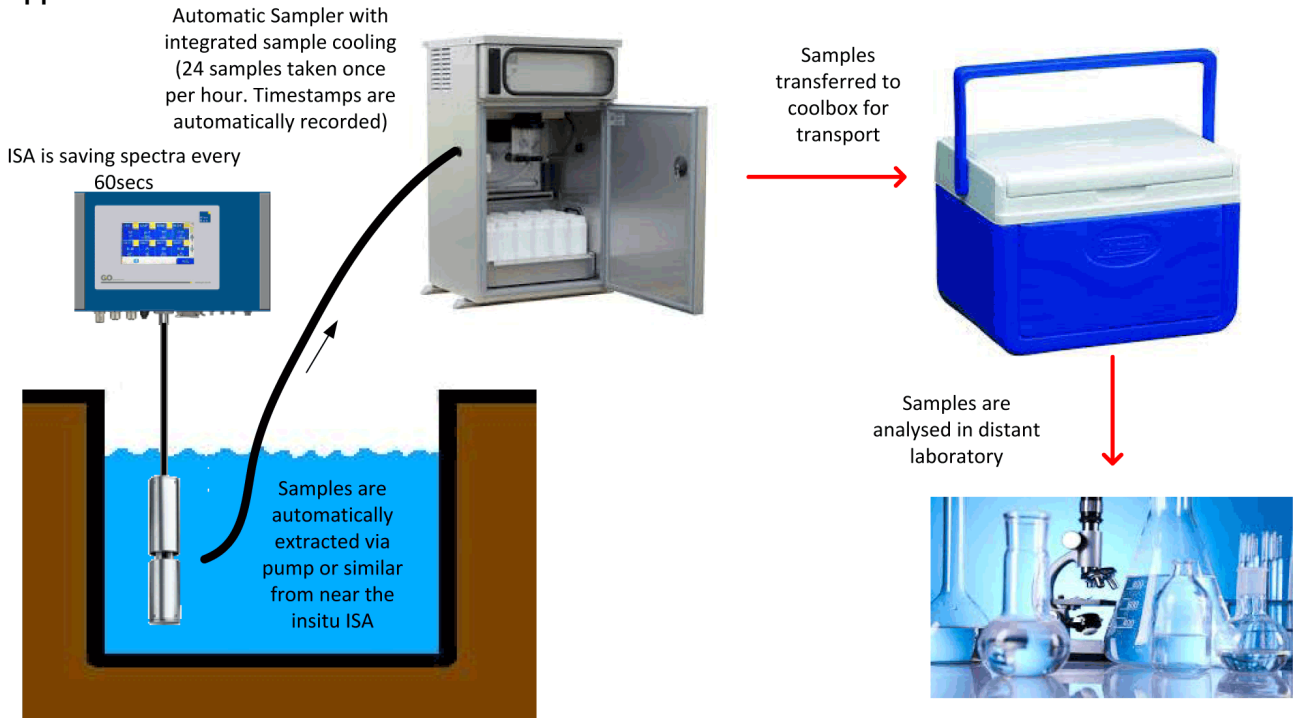

## Tips for High Accuracy Application-Specific Calibrations

### Approach 3:

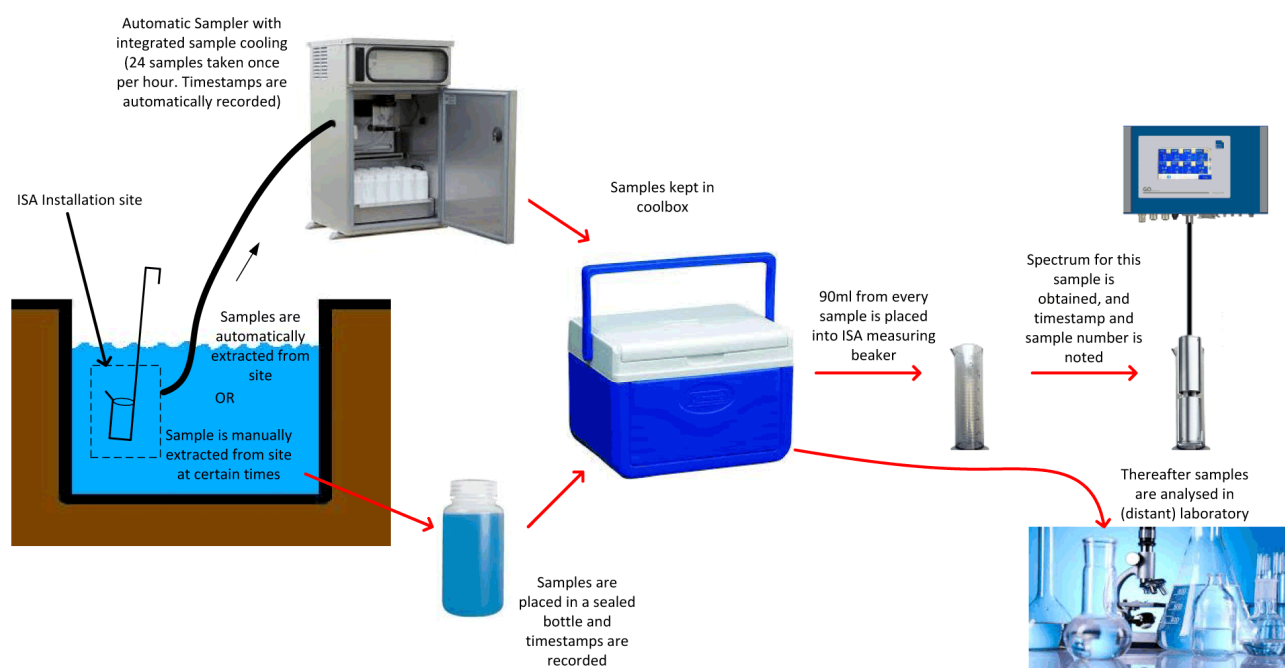

### Calibration Optimisation

With reference to point 4 under *General* above, the initial calibration performed with 25 samples can be refined by obtaining additional samples according to Approach 1 above. The new data received (reference value pairs) can be added to the initial calibration dataset, thus giving you an even more accurate calibration formula.

We recommend that you obtain at least one new reference value pair every week. This can be done as part of normal maintenance.

#### If you have questions:

[service@go-sys.de](mailto:service@go-sys.de)

+49(0)431-58080-17

GO Systemelektronik GmbH